

15388/\*\*/16



Gebruiksaanwijzing  
Notice d'emploi  
Benutzerhandbuch  
User manual  
Manual de usuario  
Manual do usuário



**PHILIPS**

Incl.

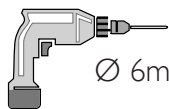
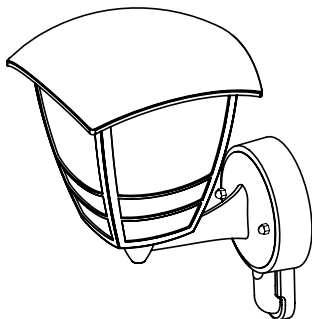

Ø 6mm



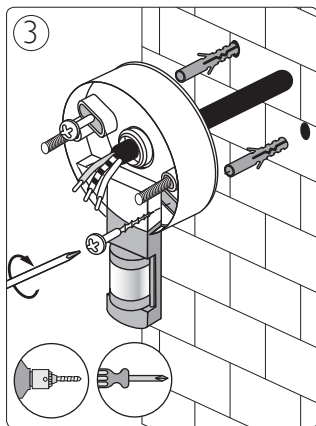
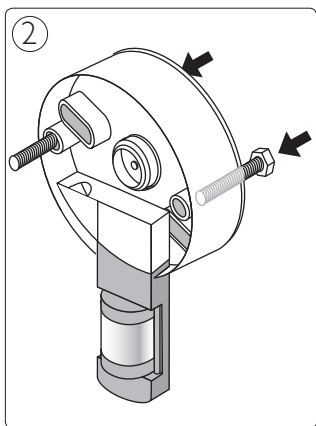
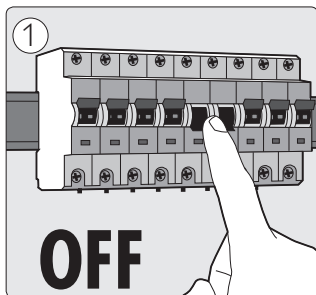
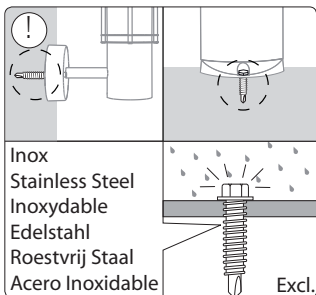

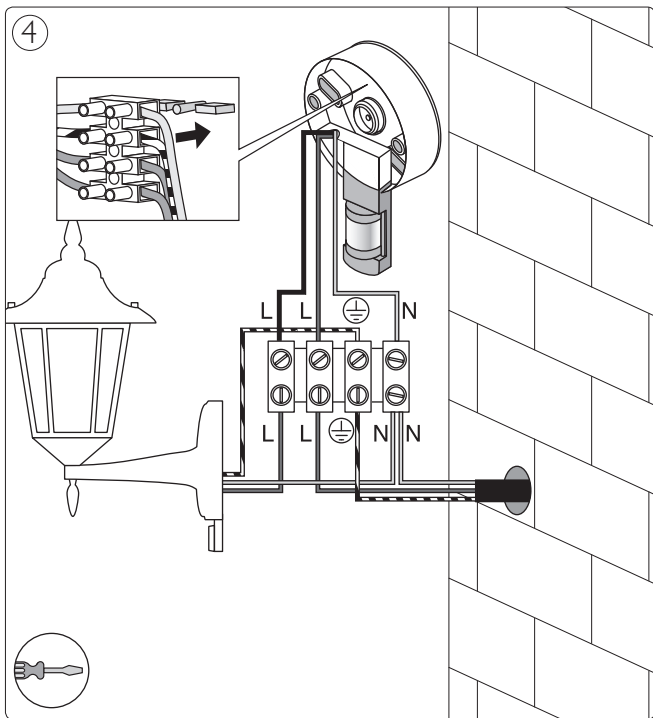

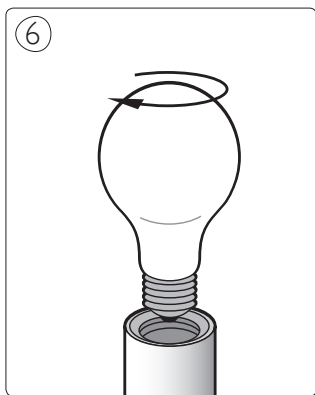
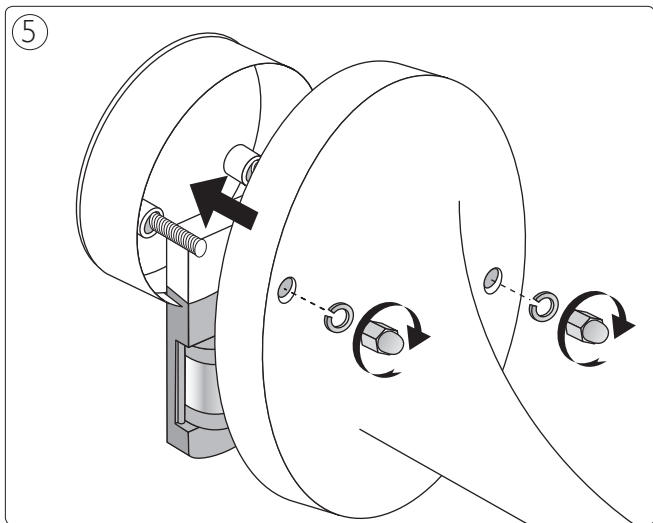

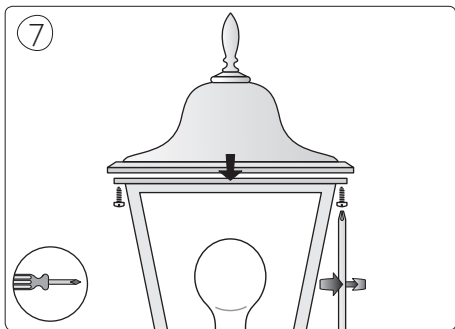





Philips Lighting Contact Centre  
Int. Business Reply Service  
I.B.R.S. / C.C.R.I. Numéro 10461  
5600 VB Eindhoven  
Pays-Bas / The Netherlands

[www.philips.com/homelighting](http://www.philips.com/homelighting)  
☎ +800 7445 4775

4404.018.31681  
Last update: 04/07/12