

NAMRON ZIGBEE FOH BRYTER BATTERI

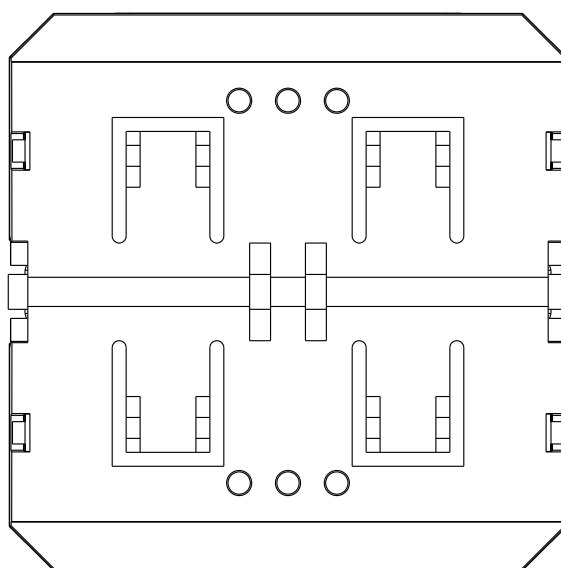

NAMRON ZIGBEE FOH BRYTER BATTERI

70100041



Important: Read All Instructions Prior to Installation

Function introduction

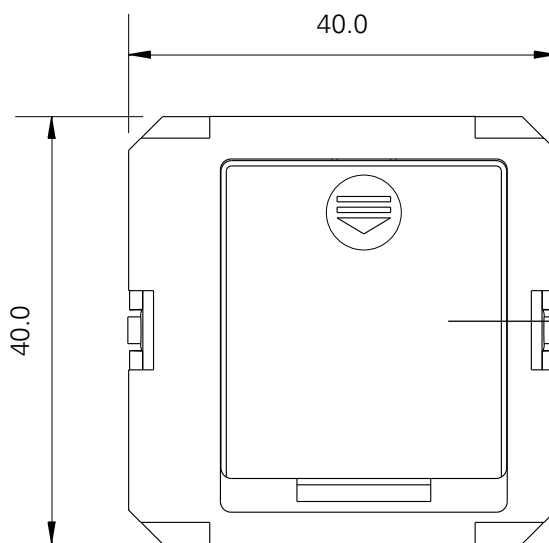
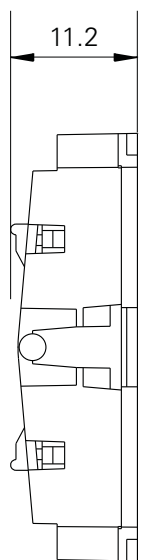
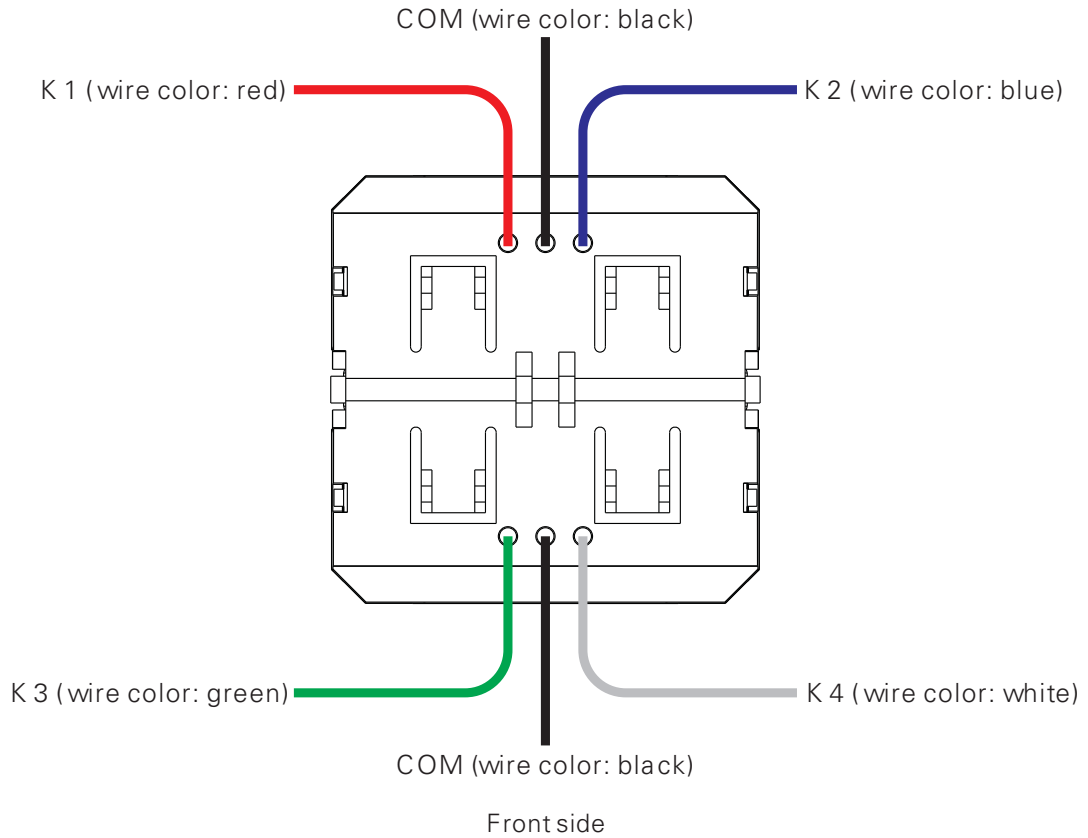

Battery: CR2430
Before the first use, please open the battery cover and remove the protective film

Back side

Product Data

Switch Type	Friends of Hue Switch
Transmission Range	10-30m (typical)
Radio Frequency	2.4GHz
Power Supply	3V(1xCR2430 battery)
Buttons	4
Dimensions	40x40x11.2mm
Operating Temperature	-20 °C ~ + 45°C
Working Humidity	10% ~ 95% RH non-condensing
Waterproof Grade	IP20
Warranty	5 years

Product Description

The Zigbee push-button coupler is a 4-channel push-button interface for simple wall/flush type box installation. You can continue to use existing switches, irrespective of the manufacturer. It is a wireless transmitter that communicates with Philips Hue bridge. The coupler adopts a CR2430 battery to power a built-in transmitter. This transmitter sends wireless radio signals that are used to remotely control the Philips Hue system.

The coupler can be configured through Hue App after added to the Hue bridge. It enables to control designated light devices in 2 designated rooms with 4 push buttons. Functions of the 4 push buttons can be configured separately through Hue App. The configurable functions includes ON/OFF, dim up/dim down, and system preset scene control.

Safety & Warnings

- This device contains a button lithium battery that shall be stored and disposed properly.
- DO NOT expose the device to moisture.

Corresponding button position of the **4 push buttons while commissioning using Hue App**

Push button wiring as follows:

Push Button 1 connecting to terminal K1

Push Button 2 connecting to terminal K2

Push Button 3 connecting to terminal K3

Push Button 4 connecting to terminal K4

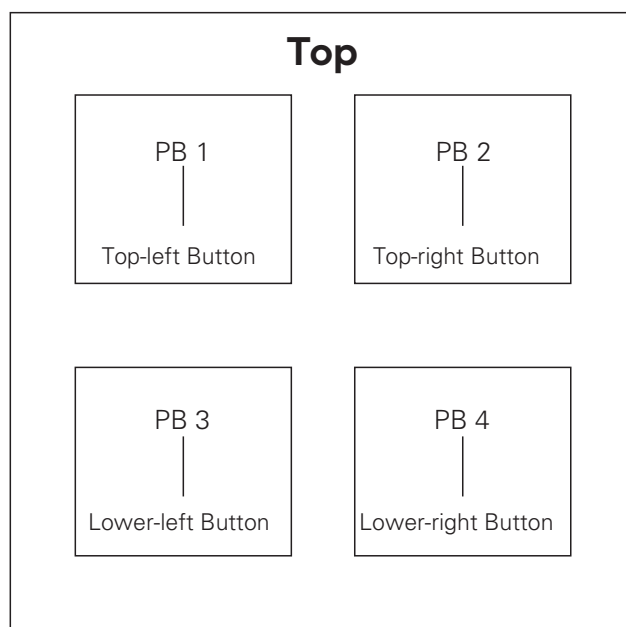

Operations

1. Configure your Hue Bridge correctly and add light devices to the Hue Bridge through Hue App as instructed.

2. Add the Coupler to Hue Bridge

Method 1: This method is applicable for the situation that all 4 push buttons are connected.

Step 1: tap "Accessory setup" on "Settings" page, then tap "Add accessory", then tap "Friends of Hue switch".

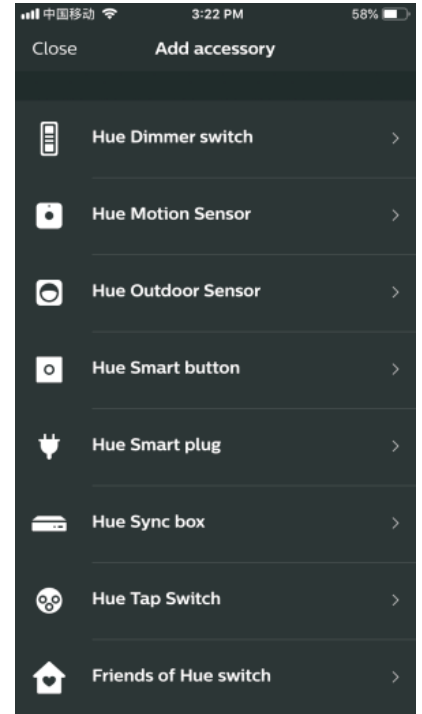
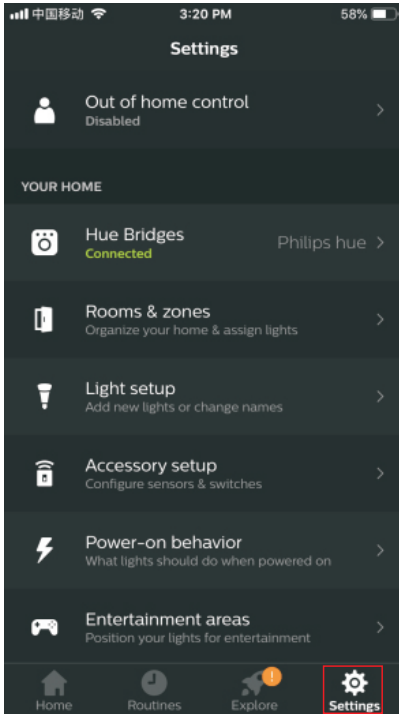

Step 2: tap a brand to select it, any brand will work. Then operate the 4 push buttons (please select the correct push buttons which correspond to the required button positions on the APP) as instructed to enable it to be added to the Hue Bridge.

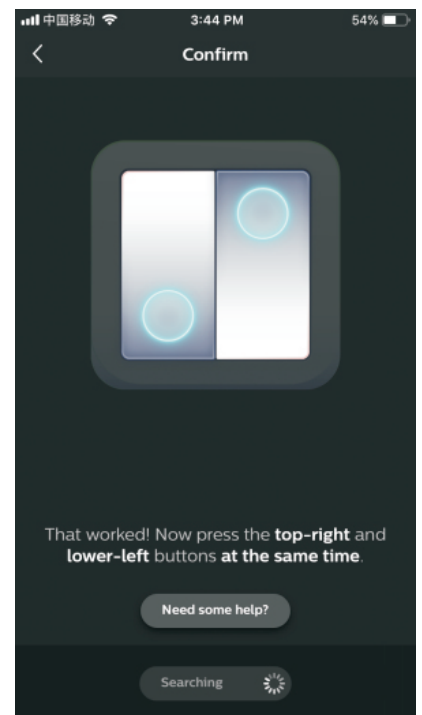
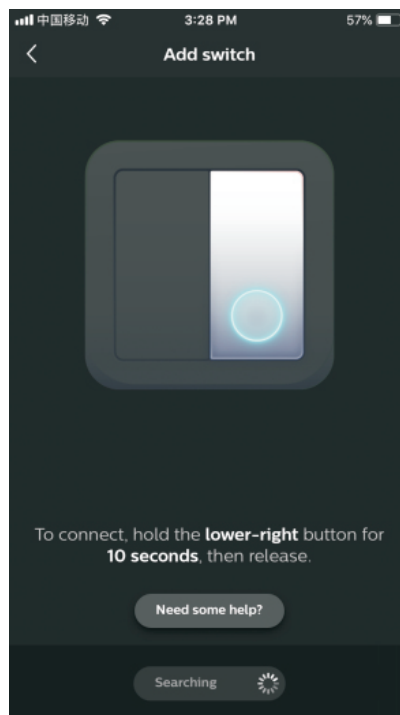
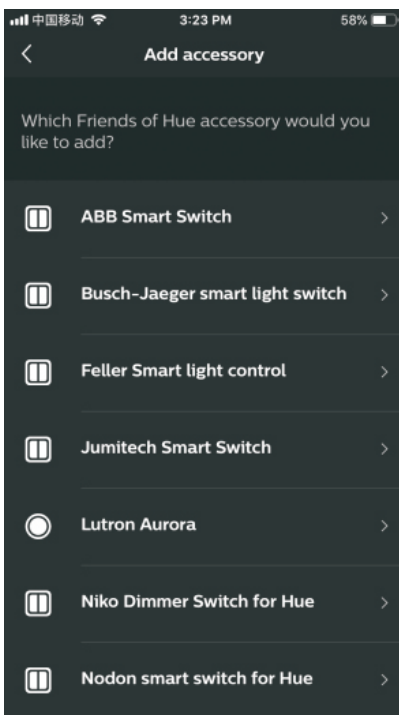

Note: different Hue Bridges may instruct you to operate different buttons during adding process, the above instruction is just an example, please kindly operate the buttons as instructed by your Hue Bridge since the buttons it requires you to operate may be different from the above example.

Method 2: This method is applicable for all situations regardless of how many push buttons connected.

Step 1: tap "Accessory setup" on "Settings" page, then tap "Add accessory", then tap "Friends of Hue switch".

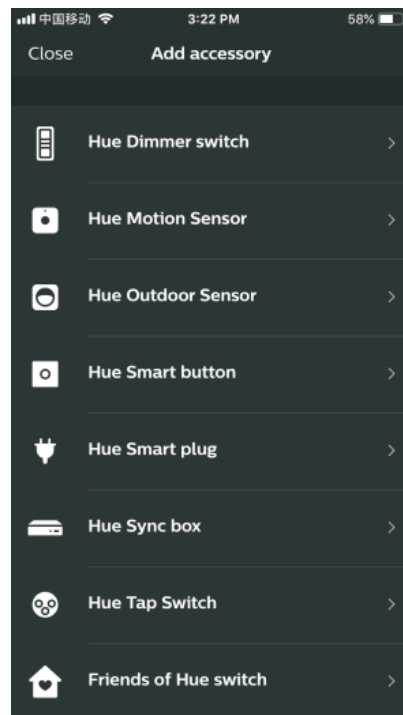
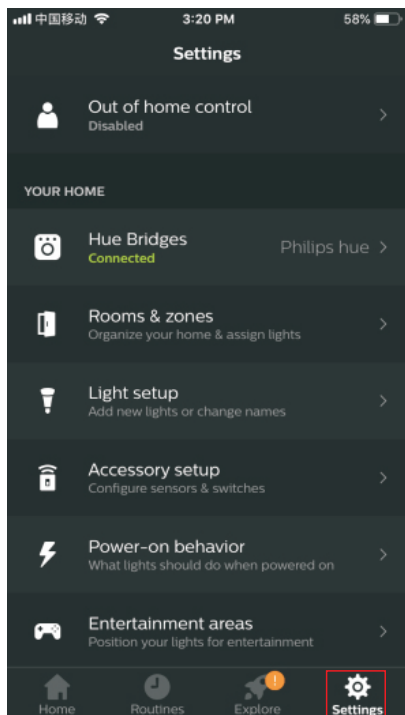

Step 2: Tap a brand to select it, any brand will work.

Step 3: Please select any one of the connected push buttons and use the same push button for the entire sequence.

Step 4: When the operation instruction "⌘ connect, hold the lower-right button for 10 seconds, then release" pops up on the App, press and hold the selected push button for over 10 seconds, then release.

Step 5: Observe the App to check whether the next step operation instruction pops up. If yes, please go to step 6.

If not, short press the selected push button once and observe the App again. If next step operation instruction pops up, go to step 6.

If not, short press the selected push button again and observe the App again, this operation shall be repeated until the next step operation instruction pops up on the App, max. repeating the operation 3 times will enable the next step operation instruction to pop up on the App.

Step 6: When next step operation instruction "That worked! Now press the top-right and lower-left buttons at the same time." pops up on the App, press and hold the selected push button for over 10 seconds, then release.

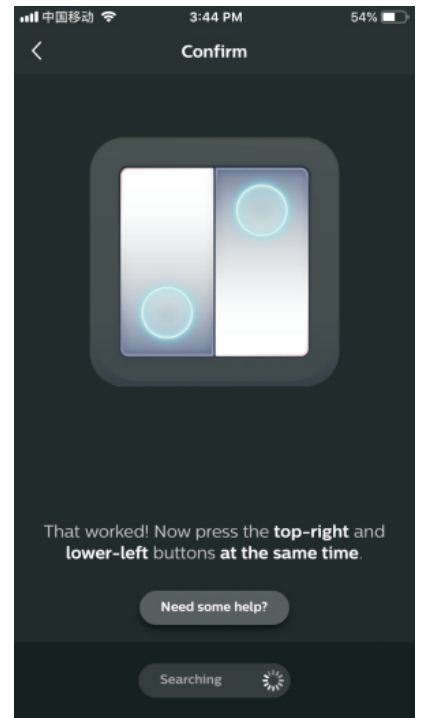
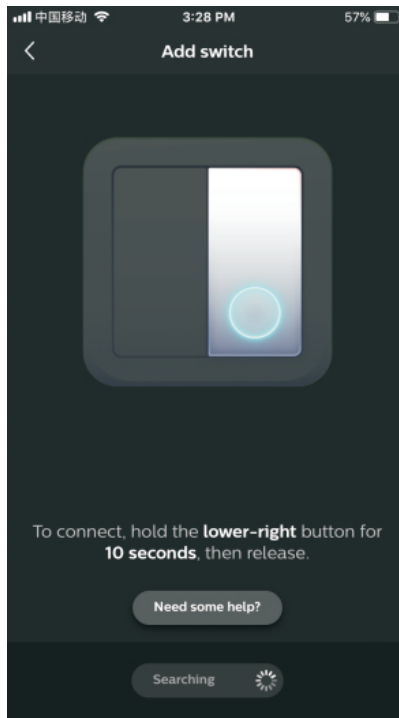
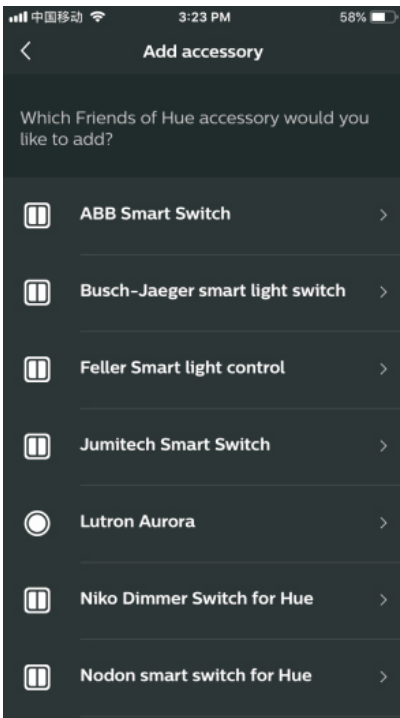

2. Select designated room/rooms to control

Step 1 : Tap to select a room to be controlled by left side on the switch, then right side.

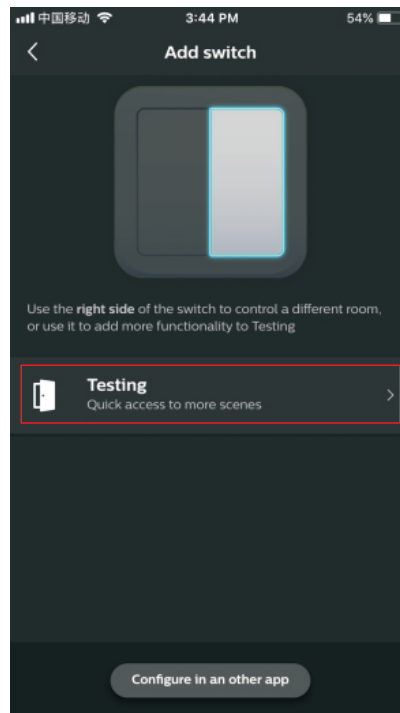
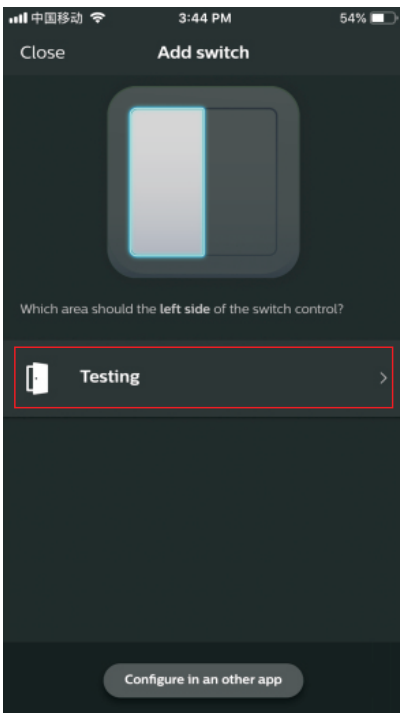

3. Configure the Switch through Hue App

Step 1 : once added successfully, you can use the system suggested setting or configure the switch as per your preferences. Just tap "Done" to use suggested setting, or tap "change settings" to configure as instructed. 4 buttons can be configured one by one separately. Tap the button area to select the button to be configured.

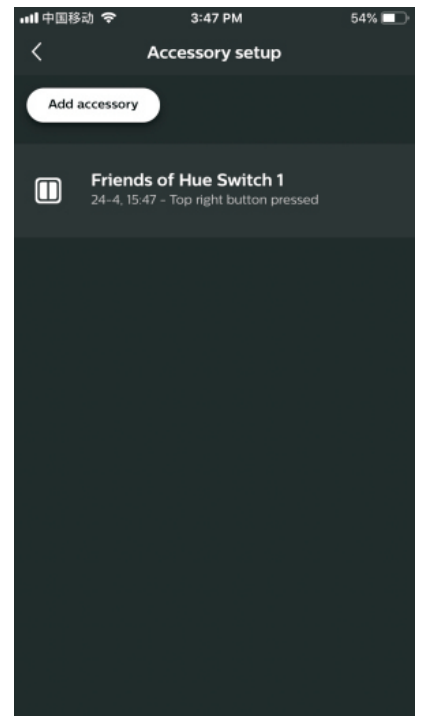
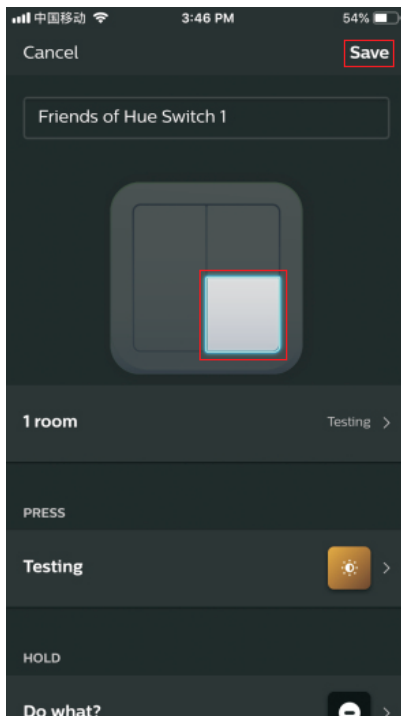
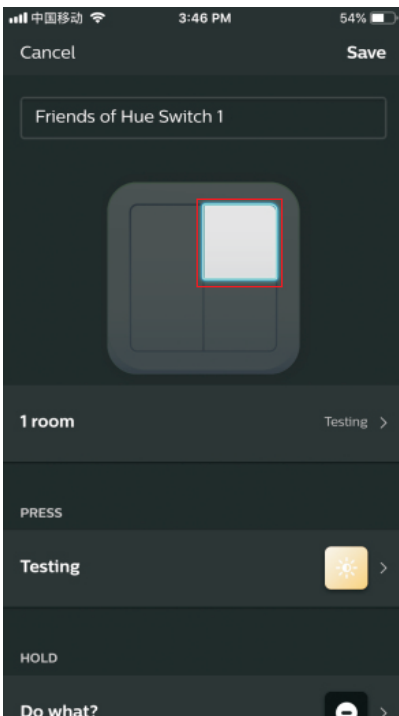
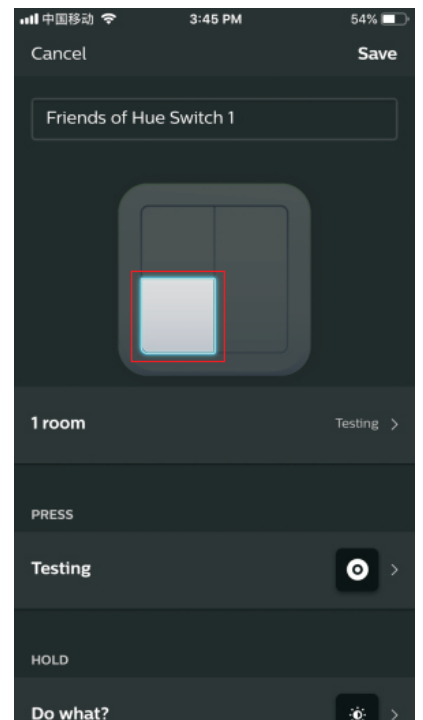
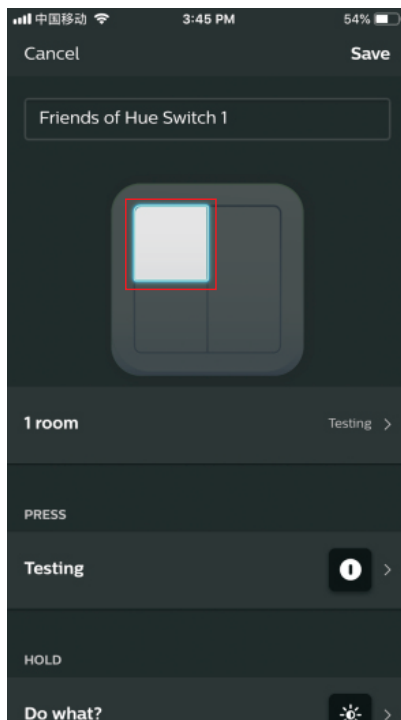
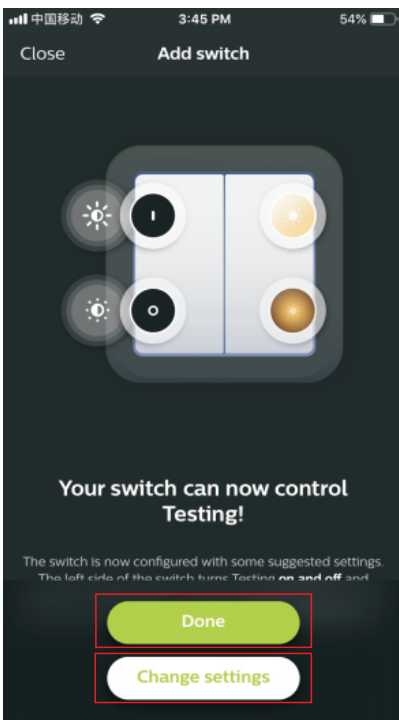

4. Control the Light Devices in the Selected Room/Rooms with the Switch

After configured successfully tap "save" at upper right corner to save the settings Then you can use the switch to control the light devices in the selected room/rooms

The key part of this controller is a universal, extremely rotary standard switch element that can be integrated in numerous frames by different manufactures as below list:

BERKER	S1, B1, B3, B7 glass
GIRA	Standard55, E2, Event, Esprit
JUNG	A500, Aplus
MERTEN	M-smart, M-Arc, M-Plan

Wiring diagram

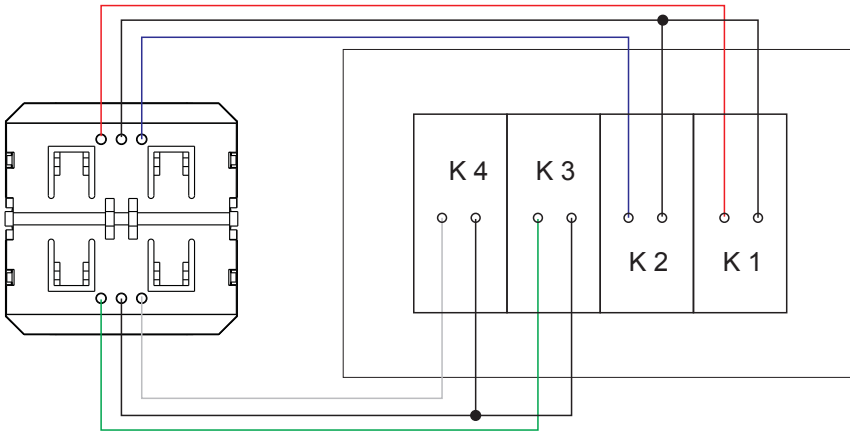

namron

the smarter choice

Namron AS
Nedre kalbakkvei 88B
1081 Oslo
Norway
post@namron.com