

**NAMRON TAKARMATUR MIRA
LED 20W SENSOR**

220-240V~ 50Hz LED IP54



LED effekt: 20W
Spenning: 220-240V~, 50Hz
Lumen: 2100lm
Kelvin: 2700K
Lysspredning: 120°
CRI: 80
Levetid: 25.000timer

LED power: 20W
Voltage: 220-240V~, 50Hz
Lumen: 2100lm
Kelvin: 2700K
Beam angle: 120°
CRI: 80
Lifetime: 25,000hours

MONTERING/MOUNTING

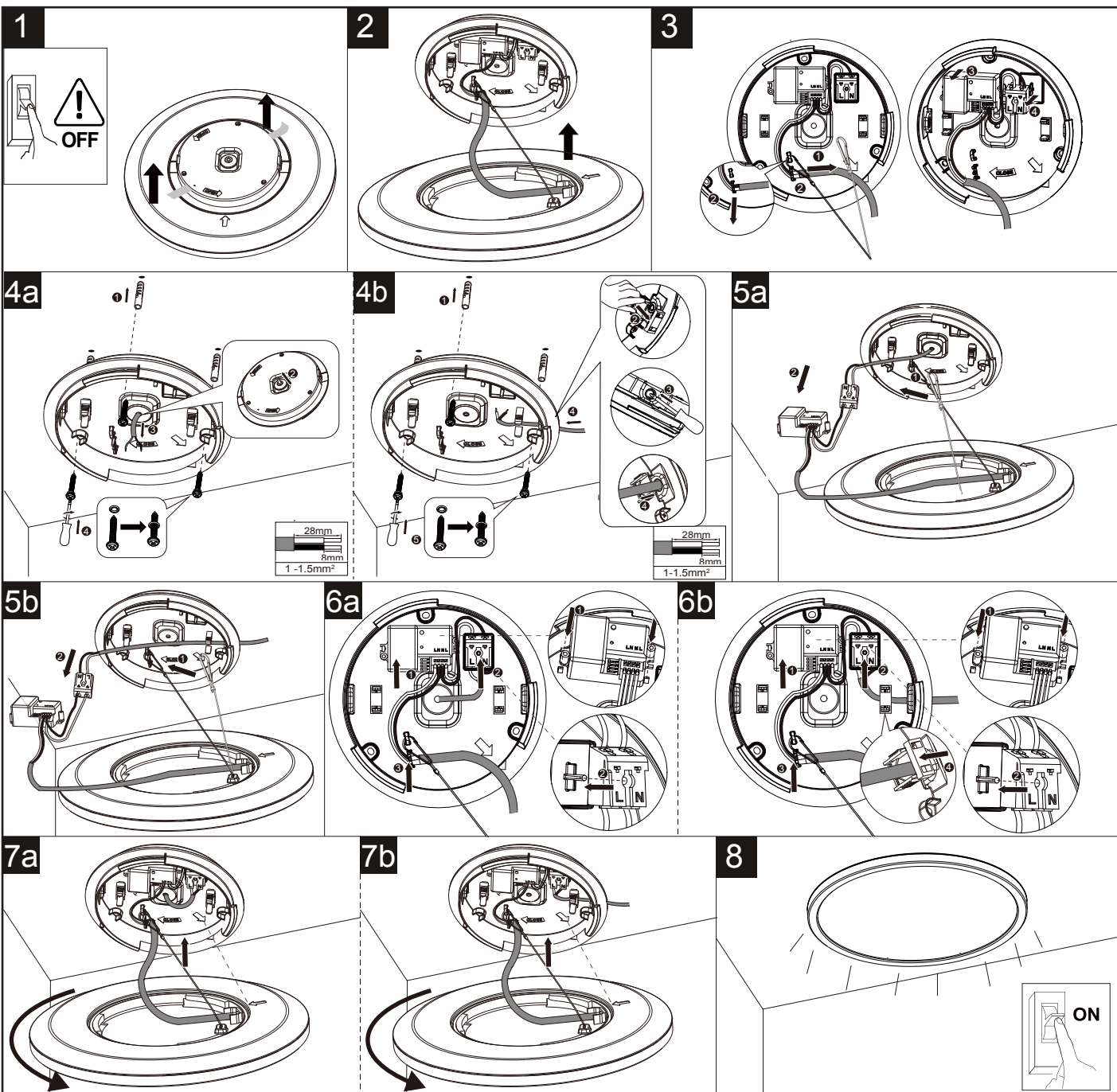

Max. number of inter-connected : 12pcs(2110476101)/15pcs(2110456101)

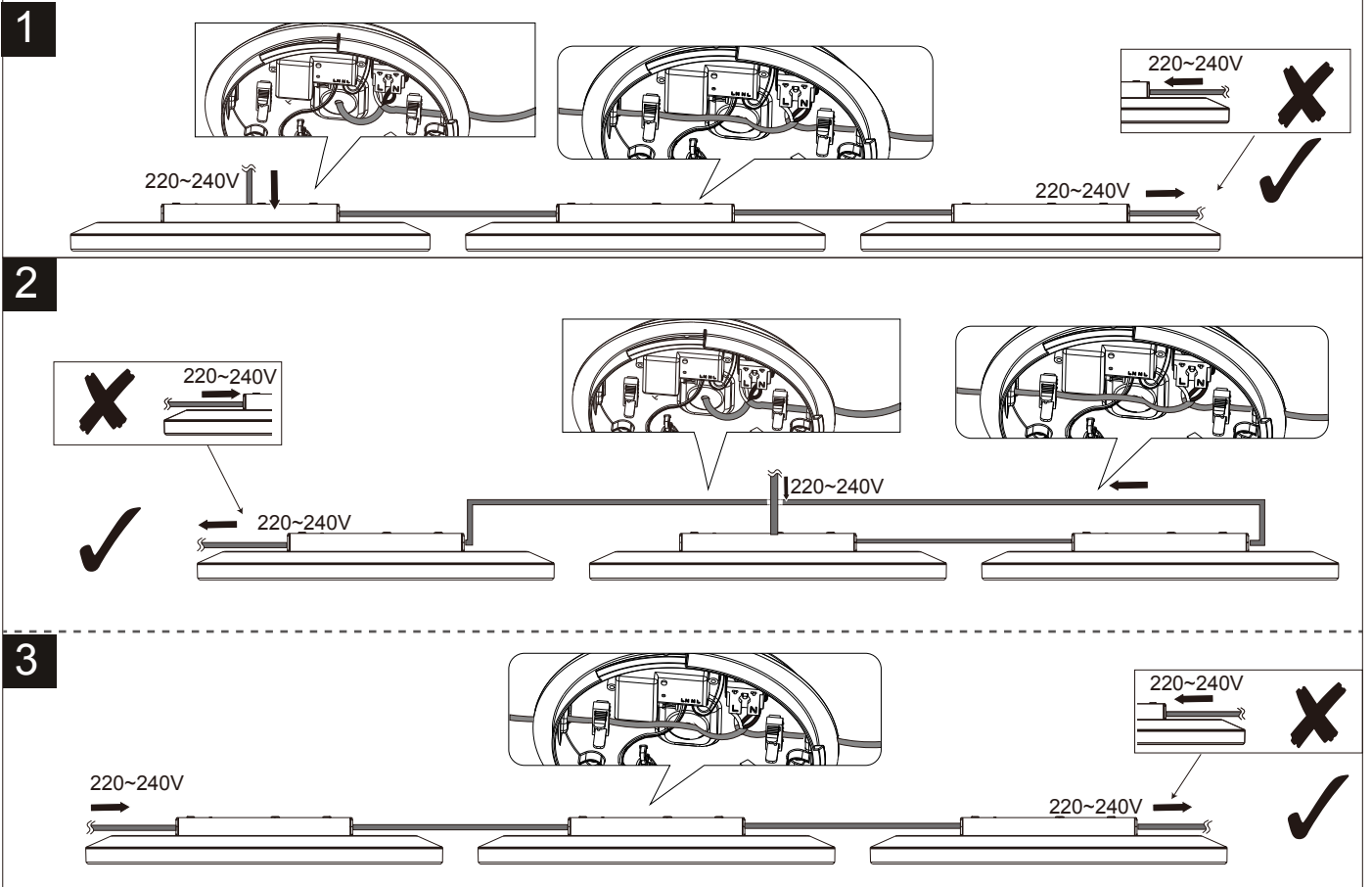

Please note that microwave sensors generate an electromagnetic (RF) field between transmitter and receiver and create an invisible volumetric detection zone. Be aware that microwave sensors are highly sensitive and can emit a signal that can even travel through glass and thin walls!

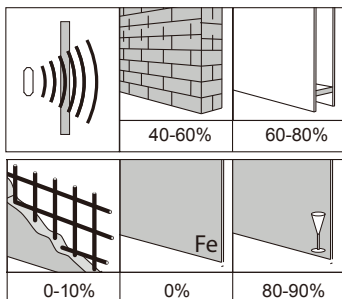

Standby power		≤ 0.5W
Microwave frequency		5.8GHz+/-75MHz
Microwave power		< 0.3mW

Sensor:

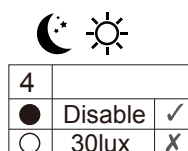
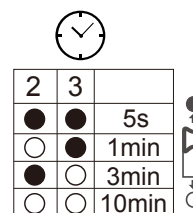
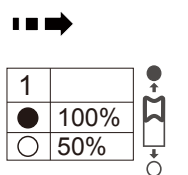
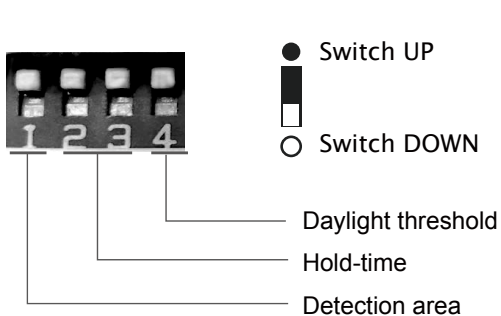
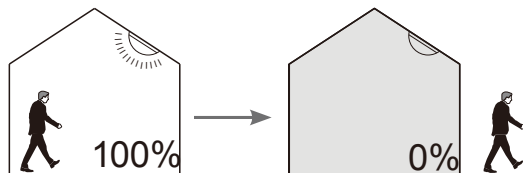

MÅL / MEASURES

