

GLOBAL Trac Lighting Systems



Quality in Focus





New Arrivals

NEW ARRIVALS

GLOBAL Trac is the most flexible way of creating elegant and appropriate lighting

Nordic Aluminium is the global market leader in lighting track systems. The success is based on the reliability, durability and high quality of the products. Nordic Aluminium is also a world class supplier. A reliable partner means stability and ensures that the products continue to be available in years to come.



One-stop service

Nordic Aluminium is a comprehensive lighting systems provider, which means you can find everything you need from one place. There are three systems to choose from: GLOBAL Trac Control is for new adaptable control applications, GLOBAL Trac Pro is the professional's choice for three-circuit systems and GLOBAL Trac Base is a compact one-circuit basic track. All you need to do is to choose the system that best meets your needs. In addition, Nordic Aluminium supplies a wide range of UL approved track systems.



Our R&D looks to the future

The focus of the Nordic Aluminium's R&D is on the needs of the customer. We use patented solutions and continue to develop new products. All products are designed by the company's R&D department, which ensures high quality throughout the product range. The R&D department also follows technical trends in the lighting business. For example, the requirements for high intensity discharge (HID) lights have been taken into consideration in all new products.



Quick and easy installation

Diverse installation options are part of the package. All installation options are quick and easy to implement. The latest trend includes snap-on brackets for the tracks. The connectors and other accessories are reliable, and the customer can trust that the installation goes nice and smoothly.





GLOBAL Trac product range

GLOBAL Trac Pro

- The most popular three-circuit track in the world
- Circuits can be controlled individually, easy to mount
- Modular solution, easy to extend/adapt
- Suitable for department stores and shops, recessed mounting version also available

GLOBAL Trac Control

- A three-circuit track for control systems
- Suitable for controlling diverse, adaptable lighting
- Can be used with all control systems, such as DALI, DMX, EIB, LON and 1-10V
- Suitable for areas that are challenging to illuminate and that require tomorrow's control systems
- Fully FELV tested and approved

GLOBAL Trac Base

- A compact one-circuit track
- Small, elegant, compact
- Connectors can be fixed fast, "snap on" technic in covers
- Suitable for small business and exhibition structures, recessed mounting version also available

GLOBAL Trac suspension parts

- Diverse suspension options for each track system, respectively
- GLOBAL Trac Pro and GLOBAL Trac Control
- GLOBAL Trac Base
- Suspension examples

GLOBAL Trac adapters

- Three-circuit universal MULTI Adapters™
- Three-circuit adapters for the GLOBAL Trac Control system
- Three-circuit adapters for the GLOBAL Trac Pro system
- One-circuit adapters for the GLOBAL Trac Base system

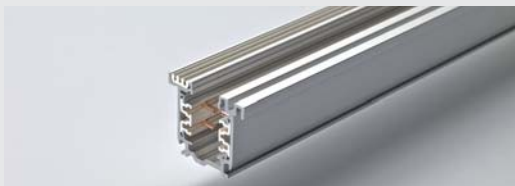
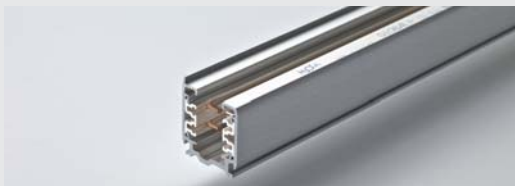



GLOBAL Trac Pro

GLOBAL Trac Pro is the most sold three-circuit lighting track system in the world. It is the quality choice of professionals and lighting manufacturers. Long experience and 100% quality assurance ensure problem-free operation. Diverse installation options are part of the package. All options are quick and easy to implement and result in overall cost savings.



For various spaces

GLOBAL Trac Pro's high load capacity and circuit-specific control option can be used in many different spaces, including shops, department stores, public buildings, restaurants, airports and offices.



Also for suspended ceilings

There is a recessed version of GLOBAL Trac Pro for suspended ceilings, too. The standard colours are anodised aluminium, white and black, as in all GLOBAL Trac Pro tracks.



Easy to extend

The modular structure of the system makes it easy to extend and adapt to various needs. Modular dimensions help designers fit the system into the appropriate space and also make on-site mounting easier. Reliable connectors ensure fast and easy installation.





GLOBAL Trac Pro

L1/L2/L3/neutral/ground 16 A/400 V. IP20.

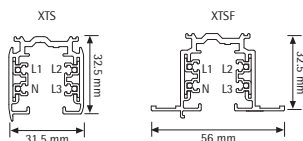
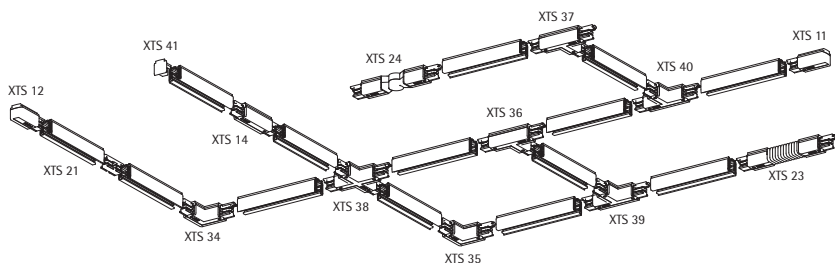

The recommended fastening distance is 1000 mm.
 NOTE: A load not heavier than 10 kg may hang on a power takeoff adapter, the pull strength being 100 N (1kp = 9.81N) and the maximum torque 2.5 Nm. (GA 69 5 kg/50 N).

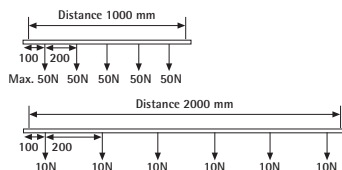

L/mm	a/mm	b/mm	c/mm	d/mm
1000	250	1000	1000	1000
2000	250			
3000	250		1500	1000
4000	250			1000

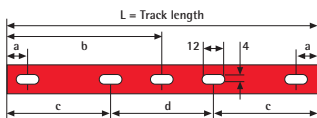

GLOBAL Trac Pro tracks

Available colours: -1 natural anodised aluminium (EN 000), -2 black (RAL 9005), -3 white (RAL 9010).

XTS 4100-4400

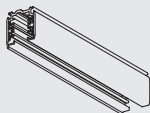

Type	EAN code	Dimensions in mm/ track length	Surface treatment/colour/ material	PCS/ Package
XTS 4100-1	64100 14 507 01-5	1000	Aluminium	10/220
XTS 4100-2	64100 14 506 01-8	1000	Black	10/220
XTS 4100-3	64100 14 507 06-0	1000	White	10/220
XTS 4200-1	64100 14 507 02-2	2000	Aluminium	10/220
XTS 4200-2	64100 14 506 02-5	2000	Black	10/220
XTS 4200-3	64100 14 507 07-7	2000	White	10/220
XTS 4300-1	64100 14 507 03-9	3000	Aluminium	10/220
XTS 4300-2	64100 14 506 03-2	3000	Black	10/220
XTS 4300-3	64100 14 507 08-4	3000	White	10/220
XTS 4400-1	64100 14 507 04-6	4000	Aluminium	10/220
XTS 4400-2	64100 14 506 04-9	4000	Black	10/220
XTS 4400-3	64100 14 507 09-1	4000	White	10/220

XTSF 4100-4400

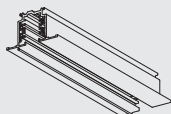

XTSF 4100-1	64100 14 507 51-0	1000	Aluminium	6/120
XTSF 4100-2	64100 14 506 51-3	1000	Black	6/120
XTSF 4100-3	64100 14 507 56-5	1000	White	6/120
XTSF 4200-1	64100 14 507 52-7	2000	Aluminium	6/120
XTSF 4200-2	64100 14 506 52-0	2000	Black	6/120
XTSF 4200-3	64100 14 507 57-2	2000	White	6/120
XTSF 4300-1	64100 14 507 53-4	3000	Aluminium	6/120
XTSF 4300-2	64100 14 506 53-7	3000	Black	6/120
XTSF 4300-3	64100 14 507 58-9	3000	White	6/120
XTSF 4400-1	64100 14 507 54-1	4000	Aluminium	6/120
XTSF 4400-2	64100 14 506 54-4	4000	Black	6/120
XTSF 4400-3	64100 14 507 59-6	4000	White	6/120

GLOBAL Trac Pro accessories

Power supply option in all connectors except XTS 21, XTS 23 and XTS 24. All materials used are halogen free and V0-self-extinguishing. Available colours: -1 grey (RAL 7040), -2 black (RAL 9005), -3 white (RAL 9010).

End feed XTS 11



Type	EAN code	Polarity ridge	Surface treatment/colour/ material	PCS/ Package
XTS 11-1	64100 14 507 15-2		Grey	10/100
XTS 11-2	64100 14 506 11-7		Black	10/100
XTS 11-3	64100 14 507 11-4		White	10/100
XTS 12-1	64100 14 507 16-9		Grey	10/100
XTS 12-2	64100 14 506 12-4		Black	10/100
XTS 12-3	64100 14 507 12-1		White	10/100
XTS 11EN-3	64100 14 522 60-5		White	1/50
XTS 12EN-3	64100 14 522 61-2		White	1/50

XTS 12



XTS 11EN

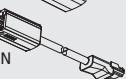

GLOBAL Trac Pro accessories

Power supply option in all connectors except XTS 21, XTS 23 and XTS 24.
Available colours: -1 grey (RAL 7040), -2 black (RAL 9005), -3 white (RAL 9010).

Middle feed

XTS 14

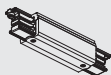

Type	EAN code	Polarity ridge	Surface treatment/colour/material	PCS/Package
XTS 14-1	64100 14 507 17-6		Grey	5/50
XTS 14-2	64100 14 506 14-8		Black	5/50
XTS 14-3	64100 14 507 14-5		White	5/50

Straight connector

XTS 21



XTS 21-1	64100 14 507 18-3		Grey	10/100
XTS 21-2	64100 14 506 21-6		Black	10/100
XTS 21-3	64100 14 507 21-3		White	10/100

Flexible corner connector

XTS 23



XTS 23-1	64100 14 507 20-6		Grey	5/25
XTS 23-2	64100 14 506 23-0		Black	5/25
XTS 23-3	64100 14 507 23-7		White	5/25

Adjustable corner connector

XTS 24





XTS 24-1	64100 14 507 19-0		Grey	5/25
XTS 24-2	64100 14 506 24-7		Black	5/25
XTS 24-3	64100 14 507 24-4		White	5/25

L-feed

XTS 34, 35







XTS 34-1	64100 14 507 25-1		Grey	5/25
XTS 34-2	64100 14 506 34-6		Black	5/25
XTS 34-3	64100 14 507 34-3		White	5/25
XTS 35-1	64100 14 507 26-8		Grey	5/25
XTS 35-2	64100 14 506 35-3		Black	5/25
XTS 35-3	64100 14 507 35-0		White	5/25

T-feed

XTS 36, 37, 39, 40



XTS 36-1	64100 14 507 27-5		Grey	5/25
XTS 36-2	64100 14 506 36-0		Black	5/25
XTS 36-3	64100 14 507 36-7		White	5/25
XTS 37-1	64100 14 507 28-2		Grey	5/25
XTS 37-2	64100 14 506 37-7		Black	5/25
XTS 37-3	64100 14 507 37-4		White	5/25
XTS 39-1	64100 14 507 30-5		Grey	5/25
XTS 39-2	64100 14 506 39-1		Black	5/25
XTS 39-3	64100 14 507 39-8		White	5/25
XTS 40-1	64100 14 507 31-2		Grey	5/25
XTS 40-2	64100 14 506 40-7		Black	5/25
XTS 40-3	64100 14 507 40-4		White	5/25

X-feed

XTS 38



XTS 38-1	64100 14 507 29-9		Grey	5/25
XTS 38-2	64100 14 506 38-4		Black	5/25
XTS 38-3	64100 14 507 38-1		White	5/25

End cap

XTS 41



XTS 41-1	64100 14 507 32-9		Grey	10/100
XTS 41-2	64100 14 506 41-4		Black	10/100
XTS 41-3	64100 14 507 41-1		White	10/100

GLOBAL Trac Pro other parts

Available colours: -1 grey (RAL 7040), -2 black (RAL 9005), -3 white (RAL 9010).

Hook base
XTAK 142

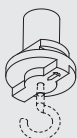

Hook
XTAK 11



Tool
XTSV 12

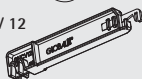

Cover plates

XTSF 10



XTSF 30



XTSF 40



Cover strip
XTSP 11



Type	EAN code		Surface treatment/colour/material	PCS/Package
XTAK 142-1	64100 14 507 43-5	For 2 mm wire/hook	Grey	50/250
XTAK 142-2	64100 14 506 42-1	For 2 mm wire/hook	Black	50/250
XTAK 142-3	64100 14 507 42-8	For 2 mm wire/hook	White	50/250
XTAK 144-1	64100 14 507 45-9	For M4 nut/rod	Grey	50/250
XTAK 144-2	64100 14 506 44-5	For M4 nut/rod	Black	50/250
XTAK 144-3	64100 14 507 44-2	For M4 nut/rod	White	50/250
XTAK 146-1	64100 14 507 47-3	For M6 nut/rod	Grey	50/250
XTAK 146-2	64100 14 506 46-9	For M6 nut/rod	Black	50/250
XTAK 146-3	64100 14 507 46-6	For M6 nut/rod	White	50/250
XTAK 11-1	64100 14 500 79-5	Hook 2 mm	Steel	100/5000
XTSV 12	64100 14 500 99-3	Bending tool for power wires	Blue	1/100
XTSF 10-1	64100 14 500 41-2	Cover plate for XTS11-14	Grey	1/100
XTSF 10-2	64100 14 506 61-2	Cover plate for XTS11-14	Black	1/100
XTSF 10-3	64100 14 507 61-9	Cover plate for XTS11-14	White	1/100
XTSF 30-1	64100 14 500 42-9	Cover plate for XTS34-40	Grey	1/100
XTSF 30-2	64100 14 506 62-9	Cover plate for XTS34-40	Black	1/100
XTSF 30-3	64100 14 507 62-6	Cover plate for XTS34-40	White	1/100
XTSF 40-1	64100 14 500 43-6	Outlet/cover plate for feeds	Grey	1/100
XTSF 40-2	64100 14 506 63-6	Outlet/cover plate for feeds	Black	1/100
XTSF 40-3	64100 14 507 63-3	Outlet/cover plate for feeds	White	1/100
XTSP 11-2	64100 14 530 99-0	Cover strip, 3000 mm	Black	10/100
XTSP 11-3	64100 14 530 98-3	Cover strip, 3000 mm	White	10/100

Use of L- and T-accessories

Red line indicates polarity ridge



Floor view

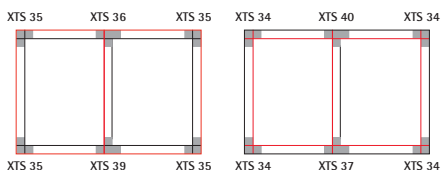



Regalskeppet Vasa is the only 17th-century ship in the world which has survived until this day. It is on display in Stockholm at the Vasa Museum – one of the most interesting tourist sights in Europe. Visitors can enjoy the museum's unique atmosphere generated by the flexible GLOBAL Trac Control lighting track system employed in the building.
Photo: Karolina Krisensson

GLOBAL Trac Control

GLOBAL Trac Control is a lighting track system that includes both normal input voltage and wires for transmitting the control signal to the lights. This makes it possible to use smart control systems without central units. Of these, the DALI, DMX, LON and EIB standards are the most widely known. Various manufacturers provide control units, detectors and fixtures for the control systems. All control systems share the same goal: to transmit the control signal to individual lights using the GLOBAL Trac Control's wires and to create dynamic lighting.



Needs-based lighting

Dynamic lighting means that the lighting changes according to the situation and need. Lights can be turned on and off, brightened or dimmed flexibly as separate groups. This also saves energy, because lights are only turned on where necessary.



Directing attention

Dynamic lighting is used to focus attention in store settings and shop windows. It is also used in museums and exhibitions to highlight details and in restaurants, auditoriums, hotel lobbies and many other places.





GLOBAL Trac Control

L1/L2/L3/neutral/ground 16 A/400 V + control 3 x 1 A/50 V FELV AC
DALI (FELV), DMX, LON, EIB, 1–10 V etc. compatible.

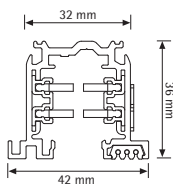
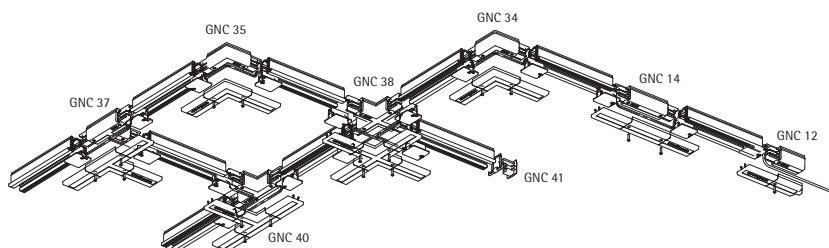

The recommended fastening distance is 1000 mm.

NOTE: A load not heavier than 10 kg may hang on a power takeoff adapter, the pull strength being 100 N (1kp = 9.81 N) and the maximum torque 2.5 Nm. (GA 69 5 kg/50 N).

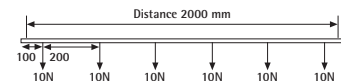
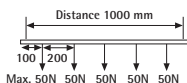

L/mm	a/mm	b/mm	c/mm	d/mm
1000	250			
2000	250	1000		
3000	250		1000	1000
4000	250		1500	1000

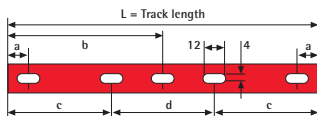

GLOBAL Trac Control tracks

Available colours: -1 natural anodised aluminium (EN 000), -2 black (RAL 9005), -3 white (RAL 9010).

GNC 7100-7400

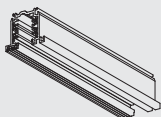

Type	EAN code	Dimensions in mm/ track length	Surface treatment/colour/ material	PCS/ Package
GNC 7100-1	64100 14 533 01-4	1000	Aluminium	6/120
GNC 7100-2	64100 14 534 01-1	1000	Black	6/120
GNC 7100-3	64100 14 535 01-8	1000	White	6/120
GNC 7200-1	64100 14 533 02-1	2000	Aluminium	6/120
GNC 7200-2	64100 14 534 02-8	2000	Black	6/120
GNC 7200-3	64100 14 535 02-5	2000	White	6/120
GNC 7300-1	64100 14 533 03-8	3000	Aluminium	6/120
GNC 7300-2	64100 14 534 03-5	3000	Black	6/120
GNC 7300-3	64100 14 535 03-2	3000	White	6/120
GNC 7400-1	64100 14 533 04-5	4000	Aluminium	6/120
GNC 7400-2	64100 14 534 04-2	4000	Black	6/120
GNC 7400-3	64100 14 535 04-9	4000	White	6/120

GLOBAL Trac Control accessories

Available colours: -1 grey (RAL 7040), -2 black (RAL 9005), -3 white (RAL 9010).

All materials used are halogen free and V0-self-extinguishing.

End feed GNC 11, 12

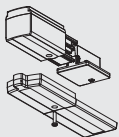

Type	EAN code	Polarity ridge	Surface treatment/colour/ material	PCS/ Package
GNC 11-1	64100 14 533 11-3		Grey	1/100
GNC 11-2	64100 14 534 11-0		Black	1/100
GNC 11-3	64100 14 535 11-7		White	1/100
GNC 12-1	64100 14 533 12-0		Grey	1/100
GNC 12-2	64100 14 534 12-7		Black	1/100
GNC 12-3	64100 14 535 12-4		White	1/100

Middle feed GNC 14

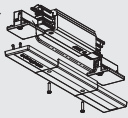

GNC 14-1	64100 14 533 14-4		Grey	1/50
GNC 14-2	64100 14 534 14-1		Black	1/50
GNC 14-3	64100 14 535 14-8		White	1/50

L-feed GNC 34, 35

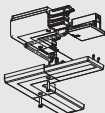



GNC 34-1	64100 14 533 34-2		Grey	1/50
GNC 34-2	64100 14 534 34-9		Black	1/50
GNC 34-3	64100 14 535 34-6		White	1/50
GNC 35-1	64100 14 533 35-9		Grey	1/50
GNC 35-2	64100 14 534 35-6		Black	1/50
GNC 35-3	64100 14 535 35-3		White	1/50

GLOBAL Trac Control accessories

Available colours: -1 grey (RAL 7040), -2 black (RAL 9005), -3 white (RAL 9010).

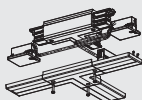
T-feed GNC 37, 40



Type	EAN code	Polarity ridge	Surface treatment/colour/material	PCS/Package
GNC 37-1	64100 14 533 37-3		Grey	1/50
GNC 37-2	64100 14 534 37-0		Black	1/50
GNC 37-3	64100 14 535 37-7		White	1/50
GNC 40-1	64100 14 533 40-3		Grey	1/50
GNC 40-2	64100 14 534 40-0		Black	1/50
GNC 40-3	64100 14 535 40-7		White	1/50

X-feed GNC 38

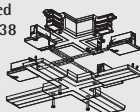

GNC 38-1	64100 14 533 38-0		Grey	1/50
GNC 38-2	64100 14 534 38-7		Black	1/50
GNC 38-3	64100 14 535 38-4		White	1/50

Control module GNCM



GNCM-1	64100 14 533 73-1	Grey	1/50
GNCM-2	64100 14 534 73-8	Black	1/50
GNCM-3	64100 14 535 73-5	White	1/50

End cap GNC 41



GNC 41-1	64100 14 533 41-0	Grey	1/100
GNC 41-2	64100 14 534 41-7	Black	1/100
GNC 41-3	64100 14 535 41-4	White	1/100

Hook base GNCA 142, 144, 146

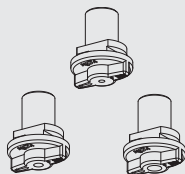

Type	EAN code		Surface treatment/colour/material	PCS/Package
GNCA 142-1	64100 14 533 42-7	For 2 mm wire/hook	Grey	50/250
GNCA 142-2	64100 14 534 42-4	For 2 mm wire/hook	Black	50/250
GNCA 142-3	64100 14 535 42-1	For 2 mm wire/hook	White	50/250
GNCA 144-1	64100 14 533 44-1	For M4 nut/rod	Grey	50/250
GNCA 144-2	64100 14 534 44-8	For M4 nut/rod	Black	50/250
GNCA 144-3	64100 14 535 44-5	For M4 nut/rod	White	50/250
GNCA 146-1	64100 14 533 46-5	For M6 nut/rod	Grey	50/250
GNCA 146-2	64100 14 534 46-2	For M6 nut/rod	Black	50/250
GNCA 146-3	64100 14 535 46-9	For M6 nut/rod	White	50/250

GLOBAL Trac Control other parts

Available colours: -1 grey (RAL 7040), -2 black (RAL 9005), -3 white (RAL 9010).

Hook
XTAK 11



Tools
GNCV 12

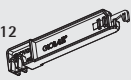

GNCT

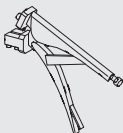

Outlet cover plate

XTSF 40



Type	EAN code		Surface treatment/colour/material	PCS/Package
XTAK 11-1	64100 14 500 79-5	Hook 2 mm	Steel	100/5000
GNVC 12		Bending tool for power wires	Grey	1/100
GNCT 73		Cutting tool for control wires	Steel	1/100
XTSF 40-1	64100 14 500 43-6	Outlet/cover plate for feeds	Grey	1/100
XTSF 40-2	64100 14 506 63-6	Outlet/cover plate for feeds	Black	1/100
XTSF 40-3	64100 14 507 63-3	Outlet/cover plate for feeds	White	1/100

Use of L- and T-accessories

Red line indicates ground polarity ridge



Floor view

DALI protocol does not allow a closed loop control wiring

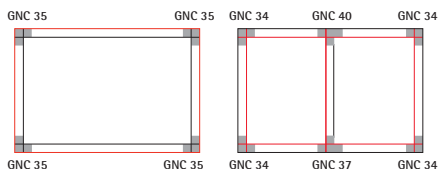



GLOBAL Trac Base

GLOBAL Trac Base is a compact, elegant-looking one-circuit basic track. The compact track is light to handle and simple to install. Diverse installation options are part of the package. Quick and easy installation results in overall cost savings.



From homes to exhibition stands

GLOBAL Trac Base is for places where the discrete and elegant appearance of the one-circuit track is most useful: homes, shop windows and exhibition structures.



Recessed version also available

There is a recessed version of GLOBAL Trac Base for suspended ceilings, too. The standard colours are anodised aluminium, white and black.



Easy connection

GLOBAL Trac Base connectors are quick and easy to mount. The connectors and other accessories are reliable, and the customer can trust that the installation goes nice and smoothly.



GLOBAL Trac Base

L1/16 A/230 V. IP20.

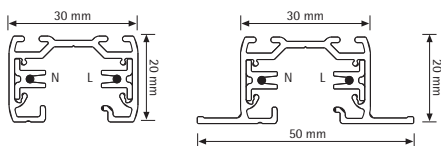
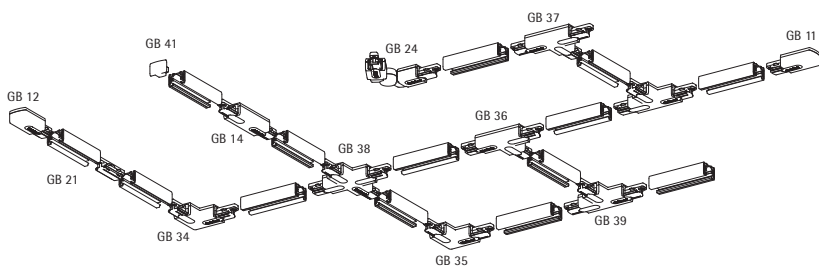

The recommended fastening distance is 1000 mm.

NOTE: A load not heavier than 10 kg may hang on a power takeoff adapter, the pull strength being 100 N (1kp = 9.81N) and the maximum torque 2.5 Nm. (GB 66 5 kg/50 N).

L/mm	a/mm	b/mm	c/mm	d/mm
1000	250	1000		
2000	250			
3000	250		1000	1000
4000	250		1500	1000

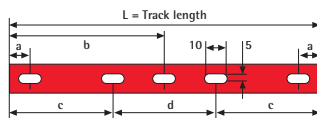
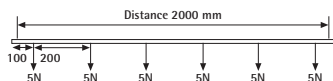
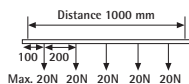

GLOBAL Trac Base tracks

Available colours: -1 natural anodised aluminium (EN 000), -2 black (RAL 9005), -3 white (RAL 9010).

GB 2100-2400



Type	EAN code	Dimensions in mm/ track length	Surface treatment/colour/ material	PCS/ Package
GB 2100-1	64100 14 509 01-9	1000	Aluminium	10/180
GB 2100-2	64100 14 508 01-2	1000	Black	10/180
GB 2100-3	64100 14 509 06-4	1000	White	10/180
GB 2200-1	64100 14 509 02-6	2000	Aluminium	10/180
GB 2200-2	64100 14 508 02-9	2000	Black	10/180
GB 2200-3	64100 14 509 07-1	2000	White	10/180
GB 2300-1	64100 14 509 03-3	3000	Aluminium	10/180
GB 2300-2	64100 14 508 03-6	3000	Black	10/180
GB 2300-3	64100 14 509 08-8	3000	White	10/180
GB 2400-1	64100 14 509 04-0	4000	Aluminium	10/180
GB 2400-2	64100 14 508 04-3	4000	Black	10/180
GB 2400-3	64100 14 509 09-5	4000	White	10/180
GBF 2100-1	64100 14 509 86-6	1000	Aluminium	5/100
GBF 2100-2	64100 14 508 91-3	1000	Black	5/100
GBF 2100-3	64100 14 509 91-0	1000	White	5/100
GBF 2200-1	64100 14 509 87-3	2000	Aluminium	5/100
GBF 2200-2	64100 14 508 92-0	2000	Black	5/100
GBF 2200-3	64100 14 509 92-7	2000	White	5/100
GBF 2300-1	64100 14 509 88-0	3000	Aluminium	5/100
GBF 2300-2	64100 14 508 93-7	3000	Black	5/100
GBF 2300-3	64100 14 509 93-4	3000	White	5/100
GBF 2400-1	64100 14 509 89-7	4000	Aluminium	5/100
GBF 2400-2	64100 14 508 94-4	4000	Black	5/100
GBF 2400-3	64100 14 509 94-1	4000	White	5/100

GBF 2100-2400



GLOBAL Track Base accessories

Power supply option in all connectors except GB 21 ja GB 24. All materials used are halogen free and V0-self-extinguishing.
Available colours: -1 grey (RAL 7040), -2 black (RAL 9005), -3 white (RAL 9010).

End feed GB 11



Type	EAN code	Polarity groove	Surface treatment/colour/ material	PCS/ Package
GB 11-1	64100 14 509 15-6		Grey	10/100
GB 11-2	64100 14 508 11-1		Black	10/100
GB 11-3	64100 14 509 11-8		White	10/100
GB 12-1	64100 14 509 16-3		Grey	10/100
GB 12-2	64100 14 508 12-8		Black	10/100
GB 12-3	64100 14 509 12-5		White	10/100
GB 11EN-3	64100 14 522 78-0		White	1/50
GB 12EN-3	64100 14 522 79-7		White	1/50

GB 12



GB 11EN

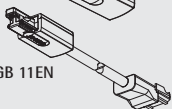

GLOBAL Trac Base accessories

Power supply option in all connectors except GB 21 ja GB 24.

Available colours: -1 grey (RAL 7040), -2 black (RAL 9005), -3 white (RAL 9010).

Middle feed GB 14

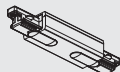

Type	EAN code	Polarity groove	Surface treatment/colour/material	PCS/Package
GB 14-1	64100 14 509 17-0		Grey	5/50
GB 14-2	64100 14 508 14-2		Black	5/50
GB 14-3	64100 14 509 14-9		White	5/50

Straight connector GB 21



GB 21-1	64100 14 509 18-7		Grey	10/100
GB 21-2	64100 14 508 21-0		Black	10/100
GB 21-3	64100 14 509 21-7		White	10/100



Adjustable corner connector GB 24



GB 24-1	64100 14 509 19-4		Grey	5/25
GB 24-2	64100 14 508 24-1		Black	5/25
GB 24-3	64100 14 509 24-8		White	5/25

L-feed GB 34, 35



GB 34-1	64100 14 509 25-5		Grey	5/25
GB 34-2	64100 14 508 34-0		Black	5/25
GB 34-3	64100 14 509 34-7		White	5/25
GB 35-1	64100 14 509 26-2		Grey	5/25
GB 35-2	64100 14 508 35-7		Black	5/25
GB 35-3	64100 14 509 35-4		White	5/25

T-feed GB 36, 37, 39, 40

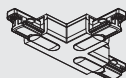

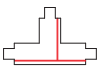
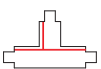
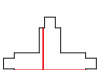
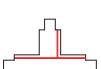
GB 36-1	64100 14 509 27-9		Grey	5/25
GB 36-2	64100 14 508 36-4		Black	5/25
GB 36-3	64100 14 509 36-1		White	5/25
GB 37-1	64100 14 509 28-6		Grey	5/25
GB 37-2	64100 14 508 37-1		Black	5/25
GB 37-3	64100 14 509 37-8		White	5/25
GB 39-1	64100 14 509 30-9		Grey	5/25
GB 39-2	64100 14 508 39-5		Black	5/25
GB 39-3	64100 14 509 39-2		White	5/25
GB 40-1	64100 14 509 31-6		Grey	5/25
GB 40-2	64100 14 508 40-1		Black	5/25
GB 40-3	64100 14 509 40-8		White	5/25

X-feed GB 38

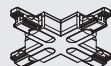

GB 38-1	64100 14 509 29-3		Grey	5/25
GB 38-2	64100 14 508 38-8		Black	5/25
GB 38-3	64100 14 509 38-5		White	5/25

End cap GB 41



GB 41-1	64100 14 509 32-3	Grey	10/100
GB 41-2	64100 14 508 41-8	Black	10/100
GB 41-3	64100 14 509 41-5	White	10/100

GLOBAL Trac Base other parts

Available colours: -1 grey (RAL 7040), -2 black (RAL 9005), -3 white (RAL 9010).

Hook base
GBA 14



Hook
XTAK 11



Outlet cover plate
GBF 10



GBF 30



Type	EAN code		Surface treatment/colour/material	PCS/Package
GBA 14-1	64100 14 509 81-1	For 2 mm hook	Grey	50/250
GBA 14-2	64100 14 508 80-7	For 2 mm hook	Black	50/250
GBA 14-3	64100 14 509 80-4	For 2 mm hook	White	50/250
XTAK 11-1	64100 14 500 79-5	Hook 2 mm	Steel	100/5000
GBF 10-2	64100 14 508 82-1	Cover plate for GB11-14	Black	1/100
GBF 10-3	64100 14 509 82-8	Cover plate for GB11-14	White	1/100
GBF 30-2	64100 14 508 83-8	Cover plate for GB34-40	Black	1/100
GBF 30-3	64100 14 509 83-5	Cover plate for GB34-40	White	1/100

Use of L- and T-accessories

Red line indicates ground polarity groove



Floor view

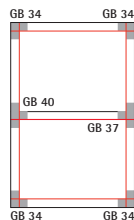
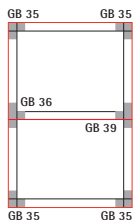

GLOBAL Trac suspension parts

GLOBAL Trac Pro, GLOBAL Trac Control

Straight

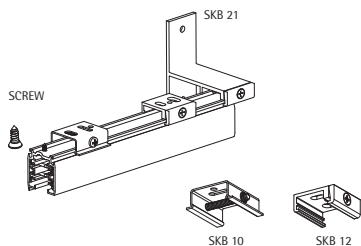

Rod suspension

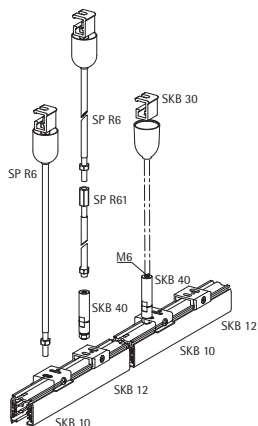



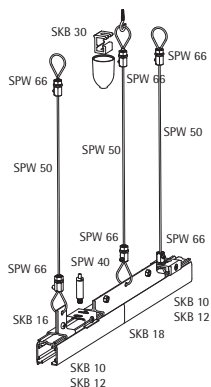
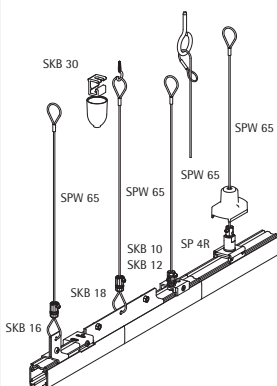
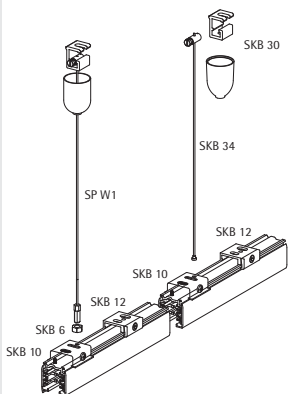



Wire suspension





GLOBAL Trac suspension parts

Available colours for parts: -1 grey (RAL 7040), -2 black (RAL 9005), -3 white (RAL 9010).

GLOBAL Trac Pro GLOBAL Trac Control		Type	EAN code		Colour	PCS/ Package
Track clamp						
SKB 10		SKB 10-1	64100 14 500 52-8	Fast mounting "click", steel	Steel	20/200
		SKB 10-2	64100 14 520 52-6	Fast mounting "click", steel	Black	20/200
		SKB 10-3	64100 14 530 52-5	Fast mounting "click", steel	White	20/200
SKB 10T		SKB 10T-1	64100 14 522 75-9	T-Bar suspension, fast mounting "click", steel	Grey	20/200
		SKB 10T-2	64100 14 522 76-6	T-Bar suspension, fast mounting "click", steel	Black	20/200
		SKB 10T-3	64100 14 522 77-3	T-Bar suspension, fast mounting "click", steel	White	20/200
SKB 12		SKB 12-1	64100 14 500 51-1	Standard, aluminium	Anodised	20/200
		SKB 12-2	64100 14 520 56-4	Standard, aluminium	Black	20/200
		SKB 12-3	64100 14 530 51-8	Standard, aluminium	White	20/200
SKB 12H		SKB 12H-1	64100 14 522 62-9	Standard, aluminium height 29 mm	Anodised	100/200
		SKB 12H-2	64100 14 522 63-6	Standard, aluminium height 29 mm	Black	100/200
		SKB 12H-3	64100 14 522 64-3	Standard, aluminium height 29 mm	White	100/200
SKB 16		SKB 16-1	64100 14 500 53-5	Suspension clamp for track	Anodised	20/200
		SKB 16-2	64100 14 522 65-0	Suspension clamp for track	Black	20/200
		SKB 16-3	64100 14 530 53-2	Suspension clamp for track	White	20/200
SKB 18		SKB 18-1	64100 14 500 55-9	Suspension clamp for track connection	Anodised	10/50
		SKB 18-2	64100 14 522 66-7	Suspension clamp for track connection	Black	10/50
		SKB 18-3	64100 14 530 55-6	Suspension clamp for track connection	White	10/50
Wall clamp						
SKB 21		SKB 21-1	64100 14 500 74-0	Wall clamp	Anodised	5/50

GLOBAL Trac Base

GBS 33



GBS 18

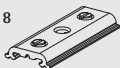

Type	EAN code		Colour	PCS/ Package
Track clamp				
GBS 33-9	64100 14 508 33-3	Suspension clamp for track	Anodised	20/200
GBS 18-9	64100 14 508 18-0	Suspension clamp for track connection	Anodised	10/100

General parts

SPR 6



Rod suspension				
SPR 6-2	64100 14 506 87-2	Rod suspension set 1000 mm	Black	1/10
SPR 6-3	64100 14 507 87-9	Rod suspension set 1000 mm	White	1/10

SPR 61



SPR 61-2	64100 14 506 90-2	Rod extension set 1000 mm	Black	1/10
SPR 61-3	64100 14 507 90-9	Rod extension set 1000 mm	White	1/10

SKB 40



SKB 40-1	64100 14 502 48-5	Height adjusting sleeve for M6 rod	Steel	10/200
----------	-------------------	------------------------------------	-------	--------



GLOBAL Trac suspension parts

Available colours for parts: -1 grey (RAL 7040), -2 black (RAL 9005), -3 white (RAL 9010).

SKB 34



Type	EAN code	Length	Closed loop	Ceiling clamp with cup	Clamp	Colour	PCS/ Package
SKB34-1	64100 14 502 34-8	1.5				Steel	10/200
SKB34-1/3M	64100 14 522 67-4	3				Steel	10/200
SKB34-1/5M	64100 14 522 68-1	5				Steel	10/200

SPW 65



SPW65-1	64100 14 533 15-1	1.5	x			Steel	10/100
---------	-------------------	-----	---	--	--	-------	--------

SPW 50



SPW50-1	64100 14 502 50-8	50				Steel	1/10
---------	-------------------	----	--	--	--	-------	------

SPW 1



SPW1-1	64100 14 522 69-8	1.5		x		Grey	10/100
SPW1-2	64100 14 506 86-5	1.5		x		Black	10/100
SPW1-2/3M	64100 14 522 70-4	3		x		Black	10/100
SPW1-2/5M	64100 14 522 71-1	5		x		Black	10/100
SPW1-3	64100 14 507 86-2	1.5		x		White	10/100
SPW1-3/3M	64100 14 522 72-8	3		x		White	10/100
SPW1-3/5M	64100 14 522 73-5	5		x		White	10/100

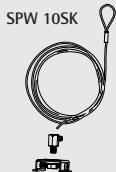

Type	EAN code	Length	Closed loop	Ceiling clamp with cup	Clamp	Colour	PCS/ Package
SPW10SK-1/1.5M	64100 14 522 93-3	1.5	x		SKB10-1	Grey	1/100
SPW10SK-1/3M	64100 14 500 00-9	3	x		SKB10-1	Grey	1/100
SPW10SK-1/5M	64100 14 500 01-6	5	x		SKB10-1	Grey	1/100
SPW10SK-2/1.5M	64100 14 522 94-0	1.5	x		SKB10-2	Black	1/100
SPW10SK-2/3M	64100 14 500 02-3	3	x		SKB10-2	Black	1/100
SPW10SK-2/5M	64100 14 500 03-0	5	x		SKB10-2	Black	1/100
SPW10SK-3/1.5M	64100 14 522 95-7	1.5	x		SKB10-3	White	1/100
SPW10SK-3/3M	64100 14 500 04-7	3	x		SKB10-3	White	1/100
SPW10SK-3/5M	64100 14 500 05-4	5	x		SKB10-3	White	1/100



SPW12SK-1/1.5M	64100 14 522 96-4	1.5	x	x	SKB12-1	Grey	1/100
SPW12SK-1/3M	64100 14 500 06-1	3	x	x	SKB12-1	Grey	1/100
SPW12SK-1/5M	64100 14 500 07-8	5	x	x	SKB12-1	Grey	1/100
SPW12SK-2/1.5M	64100 14 522 97-1	1.5	x	x	SKB12-2	Black	1/100
SPW12SK-2/3M	64100 14 500 08-5	3	x	x	SKB12-2	Black	1/100
SPW12SK-2/5M	64100 14 500 09-2	5	x	x	SKB12-2	Black	1/100
SPW12SK-3/1.5M	64100 14 522 98-8	1.5	x	x	SKB12-3	White	1/100
SPW12SK-3/3M	64100 14 500 10-8	3	x	x	SKB12-3	White	1/100
SPW12SK-3/5M	64100 14 500 11-5	5	x	x	SKB12-3	White	1/100



Type	EAN code		Colour	PCS/ Package
SPW 40-1	64100 14 502 49-2	Fast height adjusting sleeve for 1.5 mm wire	Steel	10/200



SPW 66-1	64100 14 535 16-2	Height adjusting sleeve for 1.5 mm wire	Steel	100/1000
----------	-------------------	---	-------	----------

Mounting accessories



SKB 30-1	64100 14 522 74-2	Ceiling clamp with cup	Grey	10/200
SKB 30-2	64100 14 502 44-7	Ceiling clamp with cup	Black	10/200
SKB 30-3	64100 14 530 30-3	Ceiling clamp with cup	White	10/200

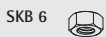

SKB 6-1	64100 14 502 41-6	M6 nut	Steel	50/5000
---------	-------------------	--------	-------	---------

Other suspension parts

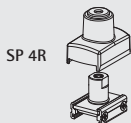

SP 4R-1	64100 14 507 68-8	Point clamp suspension for M6	Grey	10/100
SP 4R-2	64100 14 506 91-9	Point clamp suspension for M6	Black	10/100
SP 4R-3	64100 14 507 91-6	Point clamp suspension for M6	White	10/100



GLOBAL Trac adapters

The GA 100 MULTI Adapter™, designed by Nordic Aluminium, represents the latest innovation in adapter technology. The growing use of HID lights, in particular, has guided the design of this adapter. There are no delays in the phase selector switch in the transition from one phase to another. The phase selector switch at the side of the adapter makes the use comfortable. Because both ends of the adapter are fitted with a locking mechanism, it can be removed directly from the track without turning it.



Adapter for all lighting tracks

MULTI Adapters are also designed to work with other manufacturers' lighting tracks. This means that the light manufacturer or fitter does not have to worry about the track on which the light will be mounted. Nordic Aluminium's three-circuit adapters include a wide selection of MULTI Adapters. The adapters come in three standard colours: grey, white and black. Adapters include several patented solutions. The materials used are halogen free and flame resistant.



Most popular adapter in the world

Our GA 69 MULTI Adapter is the world's most sold adapter. Its quality and reliability are unequalled. Product testing and 100% quality assurance are an integral part of Nordic Aluminium's strategy.



For all power supply needs

Continuous product development is essential for Nordic Aluminium. New products include a Schuko adapter. With this product the lighting track can be used for other power supply needs than lighting. It is a useful solution for meeting electricity needs in stores and small industrial premises.





3-circuit adapters

Available colours: -1 grey (RAL 7040), -2 black (RAL 9005), -3 white (RAL 9010).

GA 100

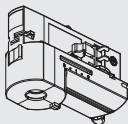

GAC 100

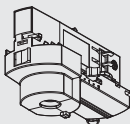

CG 100



GB 66CT



GAT 101

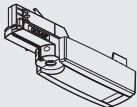

GAT 102

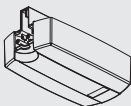

GA 100 circuit-selector adapter

Type	EAN code		Colour	PCS/ Package
GA 100-1	64100 14 530 00-6	MULTI Adapter	Grey	5/100
GA 100-2	64100 14 531 00-3	MULTI Adapter	Black	5/100
GA 100-3	64100 14 532 00-0	MULTI Adapter	White	5/100
GA 100L-1		MULTI Adapter	Grey	100/3200
GA 100L-2		MULTI Adapter	Black	100/3200
GA 100L-3		MULTI Adapter	White	100/3200
GAC 100-1	64100 14 533 00-7	MULTI Adapter control	Grey	1/50
GAC 100-2	64100 14 534 00-4	MULTI Adapter control	Black	1/50
GAC 100-3	64100 14 535 00-1	MULTI Adapter control	White	1/50

Type	EAN code		Colour	PCS/ Package
CG 100	64100 14 530 79-2	Optional cable grip		100/5000
GB 66CT	64100 14 522 51-3	Slot connection tool		1/50

Truly modular adapter: end cover can be changed to allow for GAC version or trafo box installations.

MULTI Adapter™

- 10 A, 250 V, Safety class I
- Max. pull strength 100 N
- Max. torque 2.5 Nm
- To be used with stranded wire 0.5 ...1 mm²

Slot connection. The conductors are pressed into the connectors by the cable mounting tool GB 66CT.

GAT 101 and GAT 102 Multi Device Adapter

Type	EAN code		Colour	PCS/ Package
GAT 101-1		MULTI Device Adapter	Grey	1/25
GAT 101-2		MULTI Device Adapter	Black	1/25
GAT 101-3		MULTI Device Adapter	White	1/25
GA 100 adapter body included.				
GAT 102-1		MULTI Device Adapter	Grey	25
GAT 102-2		MULTI Device Adapter	Black	25
GAT 102-3		MULTI Device Adapter	White	25

Note! To be ordered separately: GA 100 or GAC 100 adapter.

GA 69

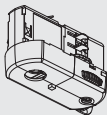

CG 69



GA 69CT



GA 69 circuit-selector adapter

Type	EAN code		Colour	PCS/ Package
GA 69-1	64100 14 530 74-7	MULTI Adapter	Grey	100/4800
GA 69-2	64100 14 520 69-4	MULTI Adapter	Black	100/4800
GA 69-3	64100 14 530 69-3	MULTI Adapter	White	100/4800
CG 69	64100 14 530 78-5	Optional cable grip		100/5000
GA 69CT	64100 14 522 52-0	Slot connection tool		1/100

MULTI Adapter™

- 6 A, 250 V, Safety class I
- Max. pull strength 50 N
- Max. torque 2.5 Nm
- To be used with stranded wire 0.5 ...1 mm²

Slot connection. The conductors are pressed into the connectors by the connector lid or by the cable mounting tool.

GAT 69 trafo housing adapter

Type	EAN code		Colour	PCS/ Package
GAT 69-1	64100 14 522 53-7		Grey	1/50
GAT 69-2	64100 14 522 54-4		Black	1/50
GAT 69-3	64100 14 522 55-1		White	1/50

MULTI Adapter™

- 6 A, 250 V, Safety class II
- Max. pull strength 50 N
- Max. torque 2.5 Nm
- To be used with stranded wire 0.5 ...1 mm²
- Delivered without transformer
- To be used only with a grounded transformer

GAT 69

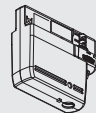



3-circuit adapters

Available colours: -1 grey (RAL 7040), -2 black (RAL 9005), -3 white (RAL 9010).

GA 300

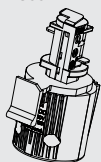

CG 100

GA 300 circuit selector adapter. Phase 2 preselected.

Type	EAN code	Colour	PCS/ Package
GA300-1	64100 14 530 43-3	Grey	5/100
GA300-2	64100 14 530 44-0	Black	5/100
GA300-3	64100 14 530 45-7	White	5/100
GA300L-1	64100 14 530 46-4	Grey	100/4800
GA300L-2	64100 14 530 47-1	Black	100/4800
GA300L-3	64100 14 530 48-8	White	100/4800

- A discreet adapter for elegant housing solutions
- For GLOBAL Trac Pro XTS and XTSF tracs
- 3 A, 250 V, Safety class I
- Max pull strength 50 N
- Max torque 2.5 Nm
- To be used with stranded wire
- Cable Grip CG 100

Slot Connection. The conductors are pressed into the connectors by the Slot Plug (included) using for example a Torx 10 screwdriver.

GA 300PP

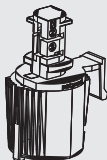

GA 300PP adapter, plastic parts.

Type	Colour	PCS/ Package
GA300PP-1	Grey	100
GA300PP-2	Black	100
GA300PP-3	White	100

- For customized solutions
- No metal connectors
- For mechanical support only

GA 300B

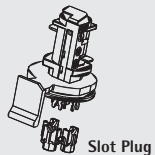

GA 300B Adapter body

Type	Colour	PCS/ Package
GA300B-1	Grey	100
GA300B-2	Black	100
GA300B-3	White	100

- For customized solutions

GA 300NB



GA 300NB Adapter body

Type	Colour	PCS/ Package
GA300NB-1	Grey	100
GA300NB-2	Black	100
GA300NB-3	White	100

- For class II customized solutions
- No ground connector
- Without locking lever



3-circuit adapters

Available colours: -1 grey (RAL 7040), -2 black (RAL 9005), -3 white (RAL 9010).

XTSA 68

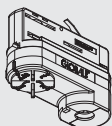

CG 75



XTSA 68 circuit-selector adapter

Type	EAN code		Colour	PCS/ Package
XTSA 68-1	64100 14 530 73-0	MULTI Adapter	Grey	10/100
XTSA 68-2	64100 14 520 68-7	MULTI Adapter	Black	10/100
XTSA 68-3	64100 14 530 68-6	MULTI Adapter	White	10/100
XTSA 68L-1		MULTI Adapter	Grey	100/3200
XTSA 68L-2		MULTI Adapter	Black	100/3200
XTSA 68L-3		MULTI Adapter	White	100/3200
CG 75	64100 14 530 77-8	Optional cable grip		100/5000

MULTI Adapter™

- 10 A, 250 V, Safety class I
- Max. pull strength 100 N
- Max. torque 2.5 Nm
- Connecting conductors max. 3 x 1.5 mm²

Screw-in connection. The conductors are connected with screws.

XTSA 67

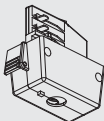

XTSA 67S



XTSA 67 power take-off adapter

Type	EAN code		Colour	PCS/ Package
XTSA 67-2	64100 14 520 67-0		Black	10/100
XTSA 67-3	64100 14 530 67-9		White	10/100
XTSA 67S-2	64100 14 500 44-3	Schuko adapter	Black	5/50
XTSA 67S-3	64100 14 531 67-6	Schuko adapter	White	5/50

- For GLOBAL Trac Pro tracks XTS and XTSF tracs
- 16 A, 250 V/400 V, Safety class I
- Max. pull strength 100 N
- Max. torque 2.5 Nm
- Connecting conductors max. 5 x 2.5 mm²

XTSA 67V-3



XTSA 67V-3 lighting plug adapter

Type	EAN code		Colour	PCS/ Package
XTSA 67V-3	64100 14 500 30-6	Lighting plug adapter	White	1/50

Nipples for 3-circuit adapters

Available colours: -1 grey (RAL 7040), -2 black (RAL 9005), -3 white (RAL 9010), -9 aluminium.

Type	EAN code	Thread	H mm	Ø mm	Colour	Strain relief	Suitable for adapter						PCS/ Package
							GA 69	GAT 69	GA 100	GAC 100	GA 300	XTSA 68	
Fixed nipple													
XTS 56/8.6-9	64100 14 522 56-8	M13 x1	8.6	9.0	Aluminium	XTSA 513	x	x	x	x	x	x	100/500
XTS 58/8-9	64100 14 501 71-6	M10 x1	8.0	7.4	Aluminium	XTSA 510	x	x	x	x	x	x	100/500
GA 510-1	64100 14 500 34-4			7.0	Grey	Included	x	x	x	x	x	x	100/500
GA 510-2	64100 14 520 86-1			7.0	Black	Included	x	x	x	x	x	x	100/500
GA 510-3	64100 14 530 86-0			7.0	White	Included	x	x	x	x	x	x	100/500
Rotating nipple *)													
XTSA 360/8-1	64100 14 500 18-4	M10 x1	8.0	7.4	Grey	XTSA510	x	x	x	x	x	x	100/500
XTSA 360/8-2	64100 14 500 19-1	M10 x1	8.0	7.4	Black	XTSA510	x	x	x	x	x	x	100/500
XTSA 360/8-3	64100 14 500 20-7	M10 x1	8.0	7.4	White	XTSA510	x	x	x	x	x	x	100/500
XTSA 360/12-1	64100 14 522 82-7	M10 x1	12.0	7.4	Grey		x	x	x	x	x	x	100/500
XTSA 360/12-2	64100 14 522 83-4	M10 x1	12.0	7.4	Black		x	x	x	x	x	x	100/500
XTSA 360/12-3	64100 14 522 84-1	M10 x1	12.0	7.4	White		x	x	x	x	x	x	100/500
XTSA 55/12-9	64100 14 501 55-6	M13 x1	12.0	9.0	Aluminium		x	x	x	x	x	x	100/500
XTSA 57/8-9	64100 14 501 59-4	M10 x1	8.0	7.4	Aluminium	XTSA 510	x	x	x	x	x	x	100/500
XTSA 57/8-9DD	64100 14 522 58-2	M10 x1	8.0	6.9	Aluminium	XTSA 510	x	x	x	x	x	x	100/500
XTSA 57/12-9	64100 14 501 57-0	M10 x1	12.0	7.4	Aluminium		x	x	x	x	x	x	100/500
XTSA 57/12-2	64100 14 520 92-2	M10 x1	12.0	7.4	Black		x	x	x	x	x	x	100/500
XTSA 57/17-9	64100 14 500 37-5	M10 x1	17.0	7.4	Aluminium		x	x	x	x	x	x	100/500
XTSA 57/11/8-9	64100 14 500 38-2	M10 x1	8.0	7.4	Aluminium	XTSA 510	x	x	x	x	x	x	100/500
XTSA 57/2/8-9	64100 14 500 39-2	M10 x1	8.0	7.4	Aluminium	XTSA 510	x	x	x	x	x	x	100/500
XTSA 63-9	64100 14 522 59-9	M10 x1			Aluminium		x	x	x	x	x	x	100/500
Nipple joint *)													
GA 37-1	64100 14 500 15-3			7.6	Grey		x	x	x	x	x	x	1/100
GA 37-2	64100 14 500 16-0			7.6	Black		x	x	x	x	x	x	1/100
GA 37-3	64100 14 500 17-7			7.6	White		x	x	x	x	x	x	1/100
GA 37M13-1	64100 14 500 27-6	M13 x1	11	7.6	Grey	XTSA 513	x	x	x	x	x	x	1/100
GA 37M13-2	64100 14 500 28-3	M13 x1	11	7.6	Black	XTSA 513	x	x	x	x	x	x	1/100
GA 37M13-3	64100 14 500 29-0	M13 x1	11	7.6	White	XTSA 513	x	x	x	x	x	x	1/100
Strain relief *)													
XTSA 510-1	64100 14 500 32-0	M10 x1	9.0	9.2	Grey								100/500
XTSA 510-2	64100 14 520 90-8	M10 x1	9.0	9.2	Black								100/500
XTSA 510-3	64100 14 530 90-7	M10 x1	9.0	9.2	White								100/500
XTSA 513-1	64100 14 500 33-7	M13 x1	9.0	9.2	Grey								100/500
XTSA 513-2	64100 14 520 91-5	M13 x1	9.0	9.2	Black								100/500
XTSA 513-3	64100 14 530 91-4	M13 x1	9.0	9.2	White								100/500
Thread													
GAM 10-9	64100 14 501 75-4	M10 x1											100/500
GAM 13-9	64100 14 501 76-1	M13 x1											100/500

*) Halogen free, V0-self-extinguishing.

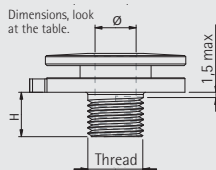



3-circuit adapter accessories

Available colours: -1 grey (RAL 7040), -2 black (RAL 9005), -3 white (RAL 9010).

GA 70

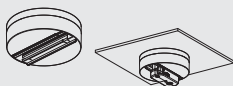

FIX Point™ adapter connector

Type	EAN code		Colour	PCS/ Package
GA 70-1	64100 14 530 92-1	FIX Point	Grey	1/50
GA 70-2	64100 14 520 93-9	FIX Point	Black	1/50
GA 70-3	64100 14 530 93-8	FIX Point	White	1/50

- For GLOBAL 3-circuit adapters
- 10 A, 250 V, Safety class I
- Max. pull strength 50 N
- Max. torque 2.5 Nm
- For surface installation

GA 30



Type	EAN code		Colour	PCS/ Package
GA30-1	64100 14 500 12-2	Fix Point	Grey	1/50
GA30-2	64100 14 500 13-9	Fix Point	Black	1/50
GA30-3	64100 14 500 14-6	Fix Point	White	1/50

- For GA300 adapter
- 3 A, 250 V, Safety class I
- Max. pull strength 50 N
- Max. torque 2.5 Nm
- For surface installation

XTSA 71

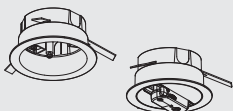

Recessed box

Type	EAN code		Colour	PCS/ Package
XTSA 71-1	64100 14 530 97-6	FIX Point recessed box	Grey	1/25
XTSA 71-2	64100 14 520 96-0	FIX Point recessed box	Black	1/25
XTSA 71-3	64100 14 530 96-9	FIX Point recessed box	White	1/25

- For recessed installation with FIX Point™ GA 70
- Adjustable to different ceiling thicknesses, max. 30 mm
- For fixing hole diameters of \emptyset 105-125 mm

XTSK 17

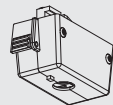

Clamps for fluorescent fitting to track

Type	EAN code		Colour	PCS/ Package
XTSK 17-2	64100 14 520 17-5	Clamp 100 N	Black	10/100
XTSK 17-3	64100 14 530 17-4	Clamp 100 N	White	10/100

XTAO 16



XTAO 16-1	64100 14 500 49-8	Clamp 120 N	Aluminium	10/100
-----------	-------------------	-------------	-----------	--------

1-circuit adapters

Available colours: -1 grey (RAL 7040), -2 black (RAL 9005), -3 white (RAL 9010).

GB 66

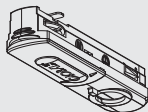

GB 66 adapter

Type	EAN code		Colour	PCS/ Package
GB 66-1	64100 14 509 65-1	Adapter	Grey	10/100
GB 66-2	64100 14 508 66-1	Adapter	Black	10/100
GB 66-3	64100 14 509 66-8	Adapter	White	10/100
GB 66L-1		Adapter	Grey	100/9600
GB 66L-2		Adapter	Black	100/9600
GB 66L-3		Adapter	White	100/9600
GB 66CT	64100 14 522 51-3	Slot connection tool		1/50

- 6 A, 250 V, Safety class I
- Max. pull strength 50 N
- Max. torque 2.5 Nm
- To be used with stranded wire 0.5 ... 1 mm²

Slot connection. The conductors are pressed into the connectors by the connector lid or by the cable mounting tool.

GB 67

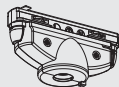

GB 67 adapter

Type	EAN code		Colour	PCS/ Package
GB 67-1	64100 14 509 73-6	Adapter *)	Grey	10/100
GB 67-2	64100 14 508 67-8	Adapter *)	Black	10/100
GB 67-3	64100 14 509 67-5	Adapter *)	White	10/100
GB 67L-1		Adapter	Grey	100/4800
GB 67L-2		Adapter	Black	100/4800
GB 67L-3		Adapter	White	100/4800

GB 67S-2	64100 14 500 45-0	Schuko adapter	Black	1/50
GB 67S-3	64100 14 509 68-2	Schuko adapter	White	1/50

*) Cable grip CG 69 included

- 16 A, 250 V, Safety class I
- Max. pull strength 100 N
- Max. torque 2.5 Nm
- Connecting conductors max. 3 x 2.5 mm²

Screw-in connection. The conductors are connected with screws.

GB 67V-3 lighting adapter

Type	EAN code		Colour	PCS/ Package
GB 67V-3	64100 14 500 31-3	Lighting plug adapter	White	1/50

GB 67S



GB 67V-3





1-circuit adapters

Available colours: -1 grey (RAL 7040), -2 black (RAL 9005), -3 white (RAL 9010).

GBT 67

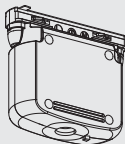

GBT 67 adapter

Type	EAN code		Colour	PCS/ Package
GBT 67-1	64100 14 509 76-7	Adapter with trafo 75 W	Grey	20/960
GBT 67-2	64100 14 508 75-3	Adapter with trafo 75 W	Black	20/960
GBT 67-3	64100 14 509 75-0	Adapter with trafo 75 W	White	20/960
GBB 67-1		Adapter without trafo	Grey	20/960
GBB 67-2		Adapter without trafo	Black	20/960
GBB 67-3		Adapter without trafo	White	20/960

- Nominal effect 75 W, Prim. 250 V 0.33 A, sec. 12 V 6.25 A, Safety class II
- Max. pull strength 100 N
- Max. torque 2.5 Nm
- Connecting conductors max. 3 x 2.5 mm²
- Suits for use with dimmable fittings
- Thermal and short circuit protection, auto-reset

GLOBAL Trac Navilight

GA300NAVI

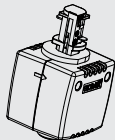

GLOBAL Trac Pro XTS- and XTSF tracs

Type	EAN code	LED	LED colour	Colour	PCS/ Package
GA300NAVI-1 W0	64100 14 530 40-2	EPR-W0-14F	Cold white	Grey	1/10
GA300NAVI-2 W0	64100 14 530 41-9	EPR-W0-14F	Cold white	Black	1/10
GA300NAVI-3 W0	64100 14 530 42-6	EPR-W0-14F	Cold white	White	1/10
GA300NAVI-1 A3K	64100 14 530 56-3	EPR-A3K-14F	Warm white	Grey	1/10
GA300NAVI-2 A3K	64100 14 530 57-0	EPR-A3K-14F	Warm white	Black	1/10
GA300NAVI-3 A3K	64100 14 530 58-7	EPR-A3K-14F	Warm white	White	1/10

- 220-240 V, 50-60 Hz, 3 W
- Circuit selection by hand, Phase 2 preselected
- Safety class II

GB67NAVI

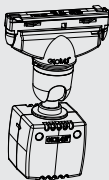





GLOBAL Trac Base GB- and GBF tracs

Type	EAN code	LED	LED colour	Colour	PCS/ Package
GB67NAVI-1 W0	64100 14 500 21-4	EPR-W0-14F	Cold white	Grey	1/100
GB67NAVI-2 W0	64100 14 500 22-1	EPR-W0-14F	Cold white	Black	1/100
GB67NAVI-3 W0	64100 14 500 23-8	EPR-W0-14F	Cold white	White	1/100
GB67NAVI-1 A3K	64100 14 500 24-5	EPR-A3K-14F	Warm white	Grey	1/100
GB67NAVI-2 A3K	64100 14 500 25-2	EPR-A3K-14F	Warm white	Black	1/100
GB67NAVI-3 A3K	64100 14 500 26-9	EPR-A3K-14F	Warm white	White	1/100

- 220-240 V, 50-60 Hz, 3 W
- Safety class II

Nipples for 1-circuit adapters

Available colours: -1 grey (RAL 7040), -2 black (RAL 9005), -3 white (RAL 9010), -9 aluminium.

Type	EAN code	Thread	H mm	Ø mm	Colour	Strain relief	Suitable for adapter				
							GB 66	GB 67	GBT 67	GBB 67	PCS/ Package
 Fixed nipple											
XTS 56/8-6-9	64100 14 522 56-8	M13 x 1	8.6	9.0	Aluminium	XTSA 513		x	x	x	100/500
XTS 58/8-9	64100 14 501 71-6	M10 x 1	8.0	7.4	Aluminium	XTSA 510		x	x	x	100/500
GA 510-1	64100 14 500 34-4			7.0	Grey	Included		x	x	x	100/500
GA 510-2	64100 14 520 86-1			7.0	Black	Included		x	x	x	100/500
GA 510-3	64100 14 530 86-0			7.0	White	Included		x	x	x	100/500
GB 510-1	64100 14 500 35-1			7.0	Grey	Included		x			100/500
GB 510-2	64100 14 508 58-6			7.0	Black	Included		x			100/500
GB 510-3	64100 14 509 58-3			7.0	White	Included		x			100/500
 Rotating nipple *)											
XTSA 360/8-1	64100 14 500 18-4	M10 x 1	8.0	7.4	Grey	XTSA 510		x	x	x	100/500
XTSA 360/8-2	64100 14 500 19-1	M10 x 1	8.0	7.4	Black	XTSA 510		x	x	x	100/500
XTSA 360/8-3	64100 14 500 20-7	M10 x 1	8.0	7.4	White	XTSA 510		x	x	x	100/500
XTSA 360/12-1	64100 14 522 82-7	M10 x 1	12.0	7.4	Grey			x	x	x	100/500
XTSA 360/12-2	64100 14 522 83-4	M10 x 1	12.0	7.4	Black			x	x	x	100/500
XTSA 360/12-3	64100 14 522 84-1	M10 x 1	12.0	7.4	White			x	x	x	100/500
XTSA 55/12-9	64100 14 501 55-6	M13 x 1	12.0	9.0	Aluminium			x	x	x	100/500
XTSA 57/8-9	64100 14 501 59-4	M10 x 1	8.0	7.4	Aluminium	XTSA 510		x	x	x	100/500
XTSA 57/8-9DD	64100 14 522 58-2	M10 x 1	8.0	6.9	Aluminium	XTSA 510		x	x	x	100/500
XTSA 57/12-9	64100 14 501 57-0	M10 x 1	12.0	7.4	Aluminium			x	x	x	100/500
XTSA 57/12-2	64100 14 520 92-2	M10 x 1	12.0	7.4	Black			x	x	x	100/500
XTSA 57/17-9	64100 14 500 37-5	M10 x 1	17.0	7.4	Aluminium			x	x	x	100/500
XTSA 57T1/8-9	64100 14 500 38-2	M10 x 1	8.0	7.4	Aluminium	XTSA 510		x	x	x	100/500
XTSA 57T2/8-9	64100 14 500 39-9	M10 x 1	8.0	7.4	Aluminium	XTSA 510		x	x	x	100/500
XTSA 63-9	64100 14 522 59-9	M10 x 1			Aluminium			x	x	x	100/500
GA 57/7-9	64100 14 500 36-8	M10 x 1	7.0	7.0	Aluminium	XTSA 510		x			100/500
GA 57/10-1	64100 14 509 56-9	M10 x 1	10.0	7.0	Grey	XTSA 510		x			100/500
GA 57/10-2	64100 14 508 57-9	M10 x 1	10.0	7.0	Black	XTSA 510		x			100/500
GA 57/10-3	64100 14 509 57-6	M10 x 1	10.0	7.0	White	XTSA 510		x			100/500
GA 57/10-9	64100 14 508 97-5	M10 x 1	10.0	7.0	Aluminium	XTSA 510		x			100/500
GA 57/21-9		M10 x 1	21.0	7.0	Aluminium			x			100/500
 Nipple joint *)											
GA 37-1	64100 14 500 15-3			7.6	Grey			x	x	x	1/100
GA 37-2	64100 14 500 16-0			7.6	Black			x	x	x	1/100
GA 37-3	64100 14 500 17-7			7.6	White			x	x	x	1/100
GA 37M13-1	64100 14 500 27-6	M13 x 1	11.0	7.6	Grey	XTSA 513		x	x	x	1/100
GA 37M13-2	64100 14 500 28-3	M13 x 1	11.0	7.6	Black	XTSA 513		x	x	x	1/100
GA 37M13-3	64100 14 500 29-0	M13 x 1	11.0	7.6	White	XTSA 513		x	x	x	1/100
 Strain relief *)											
XTSA 510-1	64100 14 500 32-0	M10 x 1	9.0	9.2	Grey						100/500
XTSA 510-2	64100 14 520 90-8	M10 x 1	9.0	9.2	Black						100/500
XTSA 510-3	64100 14 530 90-7	M10 x 1	9.0	9.2	White						100/500
XTSA 513-1	64100 14 500 33-7	M13 x 1	9.0	9.2	Grey						100/500
XTSA 513-2	64100 14 520 91-5	M13 x 1	9.0	9.2	Black						100/500
XTSA 513-3	64100 14 530 91-4	M13 x 1	9.0	9.2	White						100/500
 Thread											
GAM 10-9	64100 14 501 75-4	M10 x 1									100/500
GAM 13-9	64100 14 501 76-1	M13 x 1									100/500

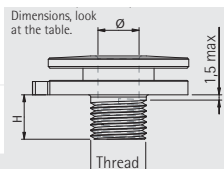

*) Halogen free, V0-self-extinguishing.

GLOBAL Trac connecting diagrams

GLOBAL Trac Pro

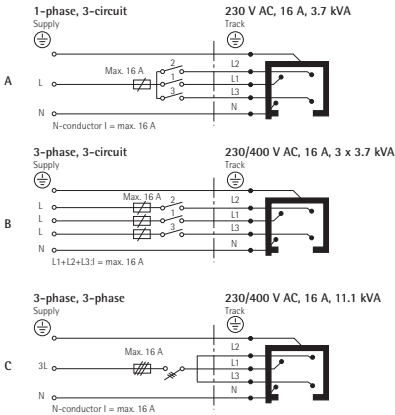

GLOBAL Trac Control

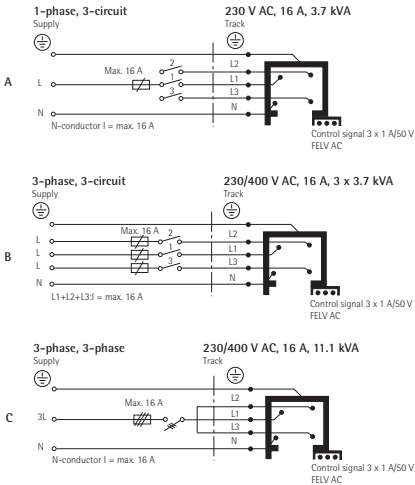

GLOBAL Trac Base

Connection
230 V AC, 16 A, 3.7 kW

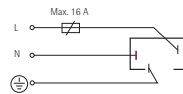

The market leader and pioneer in aluminium

Nordic Aluminium designs, manufactures and markets high quality aluminium profiles and components. The company is the leading lighting track manufacturer in the world and the domestic market leader in all its main product areas. The market leadership is the result of over 40 years of experience and determined investment in design and R&D.

Effective and precise customer service is the operational basis of Nordic Aluminium. Successful business lays its foundation on long-term partnerships in which close cooperation with clients is of key importance in each stage of the service chain. High quality standards and innovative utilization of the unique characteristics of aluminium are essential operational principles of Nordic Aluminium – be it the initial design of a product, production or refinement. That is why the company's motto is "Quality in Focus".

GLOBAL  is a registered trademark of Nordic Aluminium Plc.

MULTI Adapter™ and FIX Point™ are trademarks of Nordic Aluminium Plc.



The quality management system that Nordic Aluminium Plc use is approved by Bureau Veritas Certification and conforms with the ISO 9001:2008 standard.



The environment management system that Nordic Aluminium Plc use is approved by Bureau Veritas Certification and conforms with the ISO 14001:2004 standard.

NORDIC  ALUMINIUM

Nordic Aluminium Plc

P.O. Box 117, FI-02401 Kirkkonummi, Finland

Visiting address: Kaapelitie 68, FI-02490 Pikkala, Finland

Tel. +358 20 7660 200, fax +358 20 7660 485, www.nordicaluminium.fi