

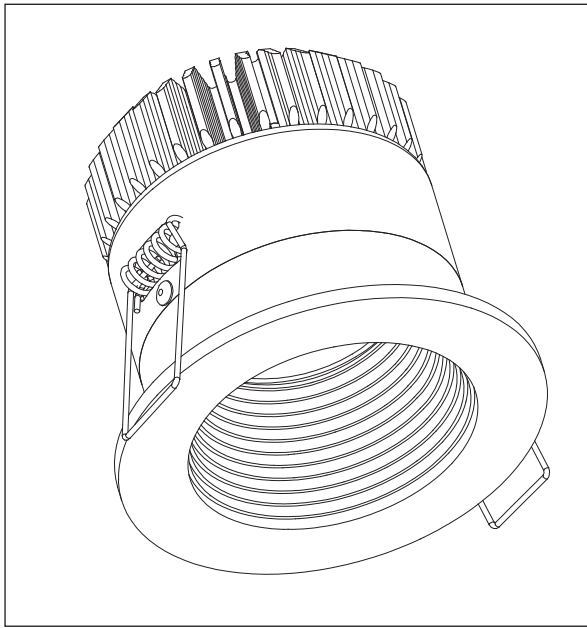

Nova Multi 7 Step

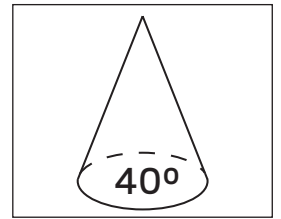

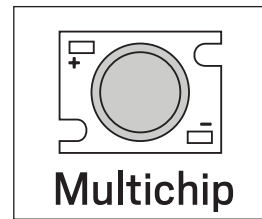
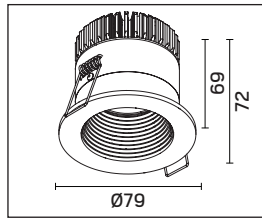

E-nr	Benämning Name Nimi	LED-färg LED color LEDin väri	Färg Color Väri	Effekt Effect Teho
74 615 47	Nova Multi 7 Step	3000K	Vit White Valkoinen	7W ± 5%





Symbolförklaring - Symbols - Merkkien selitykset

 Uppfyller kraven enligt EN-60598.
Confirms EN-60598.
Täyttää standardin EN 60598 vaatimukset.

 Avsedd för inomhusbruk.
Intended for indoor use.
Tarkoitettu sisäkäyttöön.

 Beröringsskyddad utförande för torra miljöer inomhus.
Touch-proof design for dry indoor environments.
Kosketussuojattu rakenne kuiviin sisätiloihin.

 Anger skyddsklass, klass III, för anslutning till skyddsklenspänning (SELV) via drivdon.
Class of protection. (SELV)
Ilmaisee suojausluokan, luokka III, kytketään matalaan turvajännitteeseen (SELV) muuntajan kautta.

 Får monteras i eller på normalt brännbara material.
Suitable for mounting directly on flammable surfaces, such as wood.
Voidaan asentaa palavaan materiaaliin, kuten puu.

 Får monteras i isolerade tak tillsammans med skyddsburk, Hide-a-lite Spot Guard.
Suitable for mounting on insulated roof using protective cover, Hide-a-lite Spot Guard.
Asennettaessa eristettyyn kattoon käytä suojakupua, Hide-a-lite Spot Guard tai vastaavaa.

 Anger driftström.
Working current.
Ilmaisee ohjausvirran.

 LED-ljuskälla.
LED light source
LED-valonlähde.

 Anger håltagningsmått.
Measurement of the cut out.
Asennusaukon koko.

 Armaturen seriekopplas.
Series connected fixture.
Valaisin on sarjaankytkettävä.

 Källsorteras som elkrot.
The WEEE symbol, indicating separate collection for WEEE - Waste of electrical and electronic equipment, consists of the crossed-out wheeled bin.
Lajitellaan sähköromuksi.



SÄKER INSTALLATION

Läs dessa instruktioner före installationen påbörjas och lämna den vidare till brukaren av anläggningen. Armaturen skall installeras av behörig installatör och enligt gällande föreskrifter. Se till att spänningen är frånslagen före installation eller underhåll. Installera armaturen enligt beskrivningen nedan. Placera LED-armaturer och drivdon långt ifrån värmekällor och i ett väl ventilerat utrymme. Min inbyggnadsmått i oisolerat utrymme 200x200x60mm. Vid installation i isolerade utrymmen använd Hide-a-lite Spot Guard Gles (74 667 02) eller motsvarande se bild 7.

SAFETY INSTRUCTIONS

Read these instructions carefully before commencing installation and retain for future reference. The luminaire should be installed by a licensed electrician and in accordance with local regulations. Make sure that the power is off before installation or maintenance. Install as described below.

Place the LED luminaires and the converter far away from heat sources and in a well ventilated area. Minimum dimension of uninsulated space 200x200x60mm. When installed in isolated areas, use Hide-a-lite Spot Guard Gles (74 667 02) or equivalent see picture 7.

TURVALLISUUSOHJEET

Lue nämä ohjeet ennen asentamista, ja luovuta ohjeet valaisimen seuraavalle käyttäjälle. Valaisimen saa asentaa valtuutettu asentaja voimassa olevien määräysten mukaisesti. Varmista, että jännite on kytketty pois päältä ennen asennusta ja huoltoa. Asenna valaisin jäljempänä olevan kuvasarjan mukaisesti. Aseta LED-valaisin ja muuntaja kauaksi lämmönlähteistä ja hyvin tuuletettuun tilaan. Eristämättömän tilan pienin sallittu koko on 200x200x60 mm. Asentaessasi valaisinta eristettyyn tilaan käytä Hide-a-lite Spot Guard Gles -asennuskotelo (41 005 17) tai vastaavaa katso kuva 7.

