

Comfort LED 4 inch **hidealite**

Justerbar downlight utrustad med Comfort-lins för modern och effektiv belysning.

Adjustable downlight with Comfort lens for a modern lightning.

Upotettava downlight-valaisin moderniin ja tehokkaaseen valaistukseen.

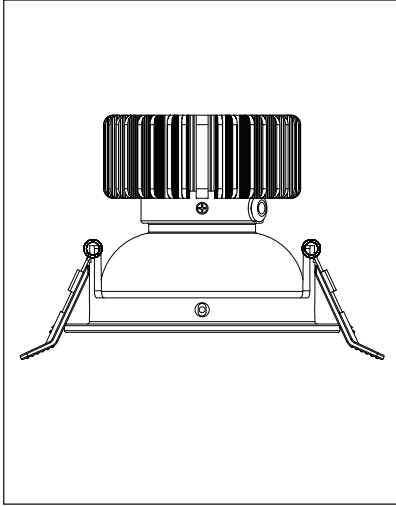

E-nr E-no Snro	Benämning Name Nimi	LED-färg LED color LEDin väri	Färg Color Väri	Effekt Effect Teho
74 502 93	Comfort LED 4 inch	3000K	Vit White Valkoinen	14W
Konverter Converter Ohjain	Effekt Effect Teho	Antal LED Numbers of LED Ledien määrä	Ingående/Utgående kablar Input/Output cables Syöttö/lähtökaapeli	
Dimbar Konverter Dimmable Converter Himmennettävä ohjain	36VDC 14W 330mA	1st LED 1pcs LED	0,5-1,5mm ²	

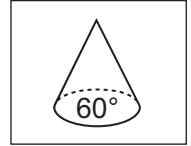
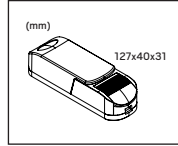
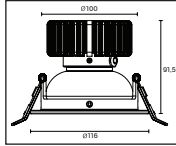

Symbolförklaring - Symbols



Uppfyller kraven enligt EN-60598
Confirms EN-60598

Täyttää standardin EN 60598 vaatimukset



Endast avsedd för inomhusbruk.

Intended only for indoor use.

Tarkoitettu sisäkäyttöön.



Beröringsskyddad utförande för torra miljöer inomhus.

Touch-proof design and protection against objects larger than 5mm.

Kosketussuojattu rakenne kuiviin sisätiloihin.



Droppskyddad utförande och petskydd mot föremål större än 5 mm.

Drip-proof design and protection against objects larger than 5mm.

Tippuvedenpitävä rakenne ja kosketussuoja yli 5 mm:n esineitä vastaan.



Anger skyddsklass, klass II, dubbelisolerung.

Class of protection.

Suojausluokka. Luokan II kaksoiseristetty valaisin.



Får monteras i eller på normalt brännbara material.

Suitable for mounting directly on flammable surfaces, such as wood.

Voidaan asentaa palavaan materiaaliin, kuten puu.



Får monteras i isolerade tak tillsammans med Hide-a-lite Spot-Guard.

Can be mounted in insulated ceilings together with Hide-a-lite Spot-Guard.

Asennettaessa eristetyn kattoon käytä suojakupua, Hide-a-lite Spot Guard tai vastaavaa.



Anger driftström.

Working current.

Ilmaisee ohjausvirran.



Anger driftspänning.

Working voltage.

Käyttöjännite.



Anger håltagningsmått.

Measurement of the cut out.

Asennusaukon koko.



Europeisk kontrollmärke för EMC, visar att produkten överensstämmer

med Europeisk EMC standard för emc elektromagnetisk kompatibilitet.

European certification mark for EMC.

Eurooppalainen EMC-sertifointimerkki osoittaa, että tuote on sähkömagneettista yhteensopivuutta koskevan eurooppalaisen EMC-standardin mukainen.



LED-ljuskälla.

LED light source.

LED-valonlähde.



Källsorteras som elskrot.

The WEEE symbol, indicating separate collection for WEEE - Waste of

electrical and electronic equipment, consists of the crossed-out wheeled bin.

Lajittellaan sähköromuksi.



SÄKER INSTALLATION

Läs dessa instruktioner före installationen påbörjas och lämna den vidare till brukaren av anläggningen. Armaturen bör installeras av behörig installatör och enligt gällande föreskrifter. Se till att spänningen är frånslagen före installation eller underhåll. Installera armaturen enligt beskrivningen nedan. Placera LED-armaturer och drivdon långt ifrån värmekällor och i ett väl ventilerat utrymme. Min inbyggnadsmått i oisolerat utrymme 200x200x150.

OBS: Strömmen får aldrig regleras på sekundärsidan, detta kan skada eller förstöra dioden.

SAFETY INSTRUCTIONS

Read these instructions carefully before commencing installation and retain for future reference. The luminaire should be installed by a licensed electrician and in accordance with local regulations. Make sure that the power is off before installation or maintenance. Install as described below.

Place the LED luminaires and the converter far away from heat sources and in a well ventilated area. Minimum dimension of uninsulated space 200x200x150.

NOTE: Never regulate the power on the secondary side, this can damage or destroy the diode.

TURVALLISUUSOHJEET

Lue nämä ohjeet ennen asentamista ja luovuta ohjeet valaisimen seuraavalle käyttäjälle. Valaisimen saa asentaa valtuutettu asentaja voimassa olevien määräysten mukaisesti. Varmista, että jännite on kytketty päältä ennen asennusta ja huoltoa. Asenna valaisin alla olevien piirustusten mukaisesti.

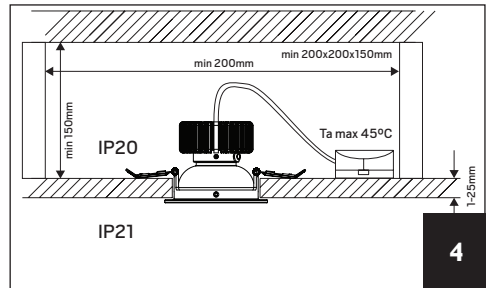
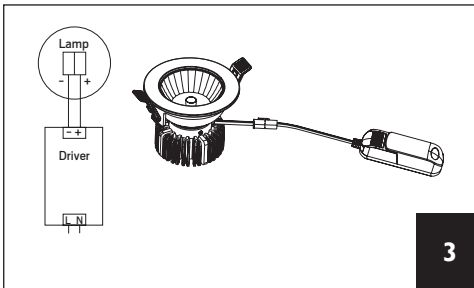
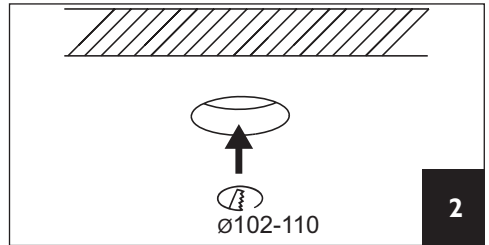
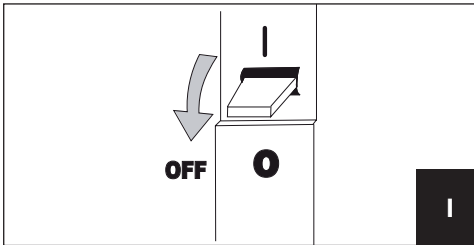

3. Anslut till LED-konverter 330mA

Connect to LED converter 330mA

Lista på rekommenderade dimrar finns på www.hidealite.se

List of recommended dimmers can be found at www.hidealite.se