

**BRUKSANVISNING
INSTRUCTION MANUAL**

PANELOVN

400W/600W/800W/1000W

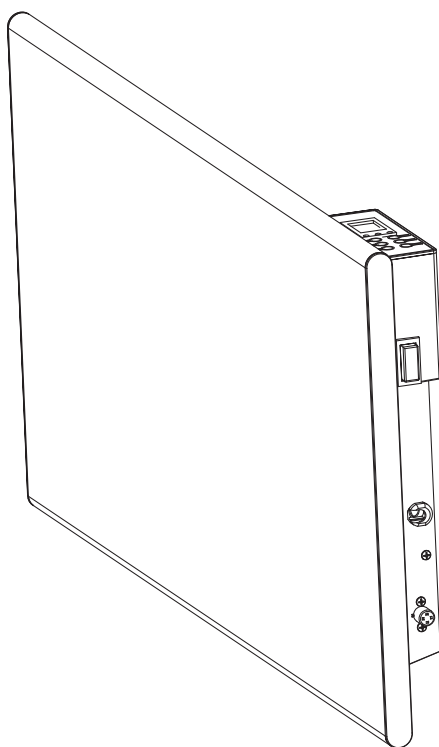

PANELOVN 400W/600W/800W/1000W

namron

220-240V~ 50-60Hz IPX4



Panelovn med moderne design, passer i de fleste miljøer. Elektronisk termostat med spareprogram. Lysende LCD display øverst på ovnen for enkel betjening.

Leveres med veggfeste. Kun til innendørs bruk.

Panel heater in modern design, suitable for most environments. Electronic thermostat with program setting. Bright LCD display placed at the top of the heater for easy operation.

Delivered with wall bracket. Indoor use only.

Effekt: 400W/600W/800W/1000W
Spenning: 220-240V~50-60Hz
Tetthetsgrad: IPX4
Elektronisk LCD display og termostat.
Inkludert 1,6 m. kabel og støpsel.

Effect: 400W/600W/800W/1000W
Operating voltage: 220-240V~50-60Hz
IP Rating: IPX4
Electronic LCD display and thermostat.
Included 1.6 m cable and plug.

MONTERING AV OVNEN/ASSEMBLY OF THE HEATER

- 1) Bor hull i veggen. Avstand mellom hull: Se skjema (a).
- 2) Skru fast festet på veggen.
- 3) Press ovnen på festet og skru fast.

- 1) Drill holes in the wall. Distance between holes: See the form (a).
- 2) Attach the clips onto the wall.
- 3) Push the heater into the clips and use screws to tighten the clips.

	a
400W	13cm
600W	13cm
800W	26cm
1000W	26cm

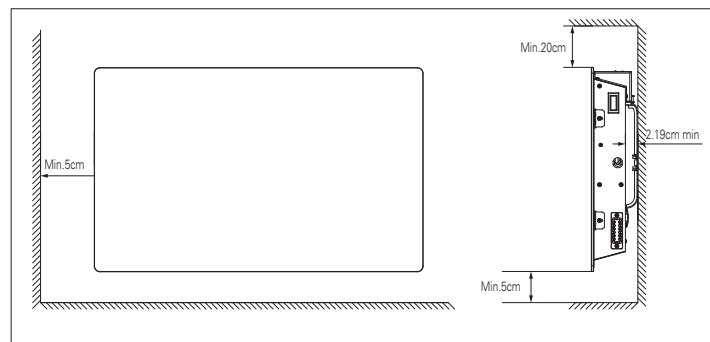
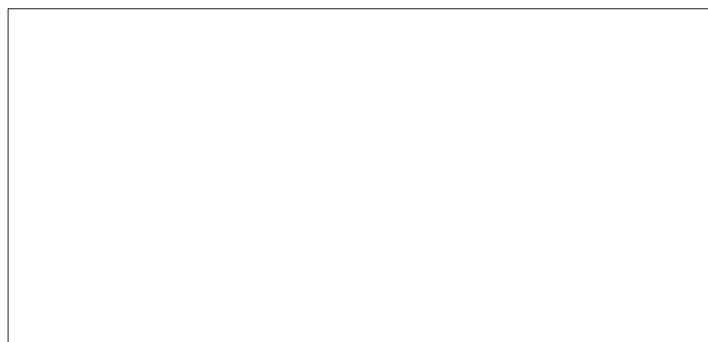
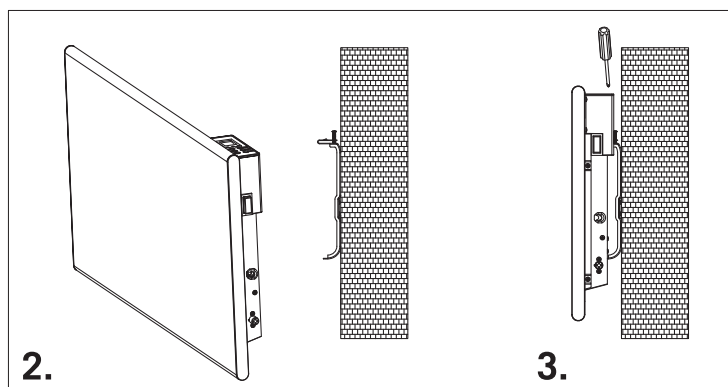
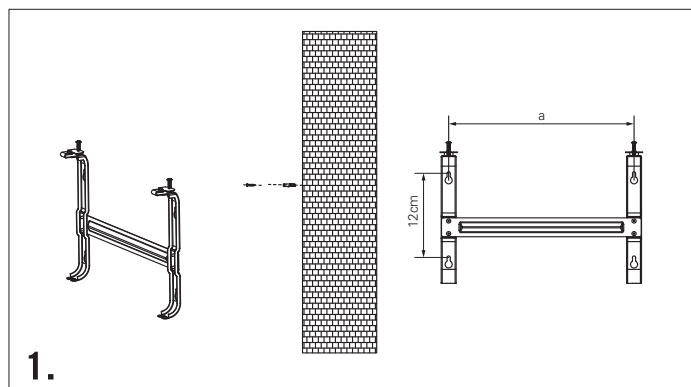

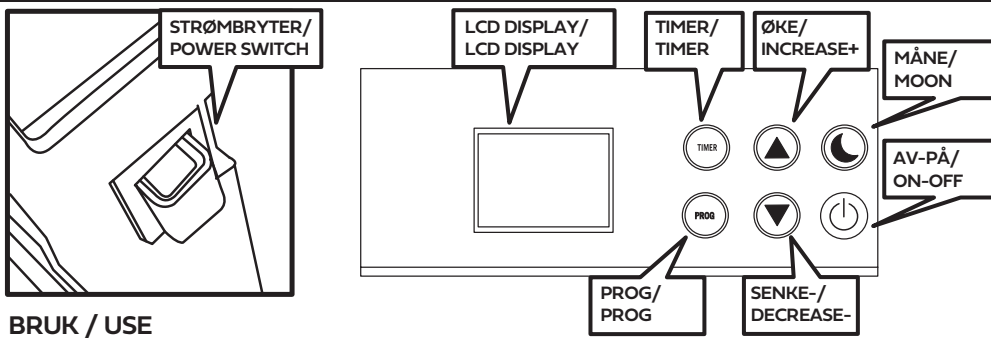

BRUK / USE

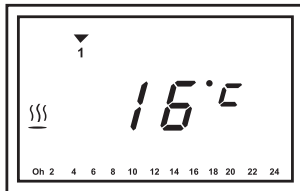

(FLG.1)

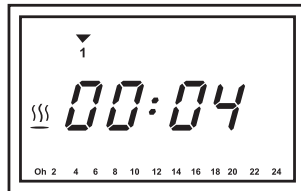

(FLG.2)

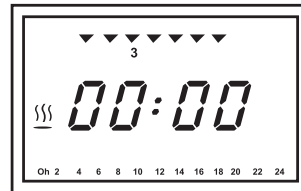

(FLG.3)

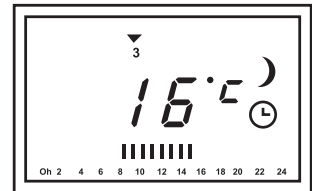

(FLG.4)

BRUK UTEN PROGRAM

1. Slå på "STRØMBRYTER", displayet vil vise temperatur og dagsymbol (FIG. 1).
2. Trykk på "AV/PÅ", ovnen vil være i standby-modus. Trykk på "AV/PÅ" igjen, ovnen vil begynne å varme og varmesymbolet vil vises.
3. Trykk "+" eller "-" for å stille inn ønsket temperatur. Temperaturen kan justeres mellom 5°C ~ 35°C. Fabrikkinstilling er 20°C.

BRUK MED UKENTLIG PROGRAM

1. Slå på "STRØMBRYTER", displayet vil vise temperatur og dagsymbol (FIG. 1).
2. Trykk på "AV/PÅ", ovnen vil være i standby-modus. Trykk på "AV/PÅ" igjen, ovnen vil begynne å varme og varmesymbolet vil vises.
3. Trykk "PROG" for å stille inn dag-/klokkeinnstilling (FIG.2). Trykk på "PROG", dagen i uken vil blinke , 1 er mandag - 7 er søndag. Trykk "+" eller "-" for å stille inn gjeldende dag. Trykk på "PROG" igjen, tiden på dagen blinker, trykk "+" eller "-" for å stille inn gjeldende tid. Trykk "PROG" for å avslutte dag-/klokkeinnstilling.

MERK: Hvis du ikke trykker på noen tast under prosessen, vil blinkingen stoppe etter 10 sekunder, og dag-/klokkeinnstillingen vil bli satt til fabrikkinnstilling som er 00:00.

4. Trykk "PROG" i 3 sekunder under arbeidsmodus, displayet viser den ukentlige programinnstillingen (FIG.3)
5. Trykk "+" eller "-" for å velge dagen du vil sette programmet, dagsymbolet blinker for den relevante dagen.
6. Trykk på "PROG" igjen, klokkeslett symbolet blinker, trykk "+" eller "-" for å velge de timene du vil stille inn programmet. 07:16 betyr 07:00 til 16:00. Det vil bli angitt som streker over de timene på døgnet som er satt, se (FIG. 4).
7. Trykk på "PROG" igjen, temperaturen blinker, trykk "+" eller "-" for å velge temperaturen du vil stille inn i programmet. 25:17 betyr 25°C i arbeidstiden du har satt, 17°C utenfor arbeidstiden du har satt.
8. Trykk på "PROG", dagsymbolet blinker, for å fortsette til de øvrige dagene i uken du vil angi et spareprogram. Trykke på "MÅNE" -tasten for å velge standardinnstilling for timene du ikke har programmert. Standard innstillinger 15°C.
9. Trykk på "TIMER" -tasten etter programinnstilling, ovnen starter da den ukentlige programmeringsmodusen (FIG.4), klokkesymbolet vil vises på displayet.

MERK: Hvis ovnen skal fungere med riktig tidssyklus, må du sette klokkeinnstillingen før programinnstillingen.

USE WITHOUT PROGRAM

1. Turn on the "POWER SWITCH", the display will show the temperature and day symbol (FIG. 1).
2. Press "ON/OFF", the heater will be in standby mode. Press "ON/OFF" again to start heating, and the heating symbol will appear.
3. Press "+" or "-" to set the temperature you want. The temperature can be adjusted between 5°C~35°C. Factory default setting is 20°C.

USE WITH WEEKLY PROGRAM

1. Turn on the "POWER SWITCH", the display will show the temperature and day symbol (FIG. 1).
2. Press "ON/OFF", the heater will be in standby mode. Press "ON/OFF" again to start heating, and the heating symbol will appear.
3. Press "PROG", to adjust the day and clock setting (FIG.2). Press "PROG" the day symbol will blink, press "+" or "-" to set the day of the week, 1 is Monday - 7 is Sunday. Press "PROG" again and the time will blink, press "+" or "-" to set the time of the day. Press "PROG" when finished to end the clock setting.

NOTE: If you don't press any key during the process, the blinking will be stopped in 10seconds. The heater will work in the wrong program period.

4. Press "PROG" for 3 seconds under working mode, the display will show the weekly program setting(FIG.3)
5. Press "+" or "-" to choose the day you want to set the program, the day symbol will blink for the relevant day.
6. Press "PROG" again and the hour will blink, press "+" or "-" to choose the hours you want to set the program, 7:16 means 7am to 4pm. The time zone symbol will appear. (FIG.4.)
7. Press "PROG" again and the temperature will blink, press "+" or "-" to choose the temperature you want to set the program, 25:17 means 25°C in the program period and 17°C outside the program period.
8. Press "PROG" and the day symbol will blink, to continue the rest of the days in the week you want to set the program. Press "MOON" to choose default setting temperature for the hours you have not programmed, default setting temperature is 15°C.
9. Press "TIMER" button after program setting, the heater will directly start the weekly program working mode (FIG.4), the clock symbol will appear on the display.

NOTE: The time setting should be done before the program setting, so the heater can work under correct program period.

<p>Åpentvinduminne Window open remind</p>	<p>I tilfelle et vindu åpnes i rommet, har ovnen en åpen vindu minnefunksjon. Hvis temperaturen synker mer enn 5 ° C i løpet av 10 minutter, blinker vindussymbolet på LCD-skjermen raskt, trykk på en vilkårlig tast på displayet for å stoppe det. Så fungerer ovnen som forrige program. Hvis det blinker kontinuerlig i løpet av 10 minutter, vil varmeapparatet automatisk fungere som Anti-frost-modus (10 ° C), til noen trykker på en hvilken som helst tast på displayet, så fungerer varmeren som forrige program.</p> <p>In case of a window is open in the room, the heater has a window opening remind function. If the temperature drops more than 5°C within 10minutes, the window symbol on the LCD display will be blinking rapidly, press any key on the display can stop it. Then the heater will be working as the previous program. If it it blinking continually over 10 minutes, the heater will be automatically work as Anti-frost mode (10°C), until someone presses any key on the display, then the heater will work as the previous program.</p>
<p>Strømbryddpåminnelse Power cut remind</p>	<p>I tilfelle strømbrydd vil displayet begynne å blinke for å indikere at det har oppstått et strømbrydd. Trykk på hvilken som helst tast på termostaten for å stoppe blinkingen.</p> <p>Merk: Varmeapparatet har en 24-timers minnefunksjon. Hvis strømmen er tilbake innen 24 timer, fungerer varmeren i samme program og tid som forrige innstilling.</p> <p>In case of a power outage, the display will start to blinking indicating that a power outage has occurred. Press any key on the thermostat to stop the blinking.</p> <p>Note: The heater has a 24hour memory function. If the power is back within 24hour, the heater will work in the same program and time as previous setting.</p>
<p>Barnesikring Child Lock</p>	<p>Termostaten kan låses ved å holde inne både "+" og "-" knappene i 3 sekunder. Gjenta samme fremgangsmåte for å låse opp termostaten igjen.</p> <p>The thermostat could be locked by holding down both "+" and "-" buttons for 3 seconds. Repeat the same procedure to unlock the thermostat again.</p>
<p>Tilbakestill termostaten til standardinnstillingen Reset the thermostat to default setting</p>	<p>Trykk på "AV/PÅ" i 5 sekunder, ovnen vil gå tilbake til standardinnstillingen.</p> <p>Press "ON/OFF" for 5 seconds, the heater will revert to default setting.</p>
<p>Informasjon første gangs bruk Information for first time use</p>	<p>Ovnen bør settes på maksimal temperatur 30 minutter for å brenne elementet rent. Noe lukt kan oppstå når dette gjøres.</p> <p>The heater should be set to maximal temperature for 30 minutes to burn the element clean. Some smell may occur.</p>

MÅL / MEASURES

400W

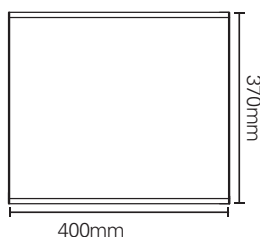

600W

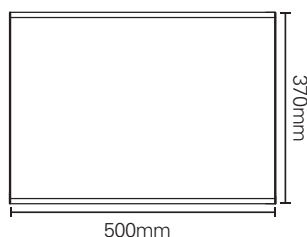

800W

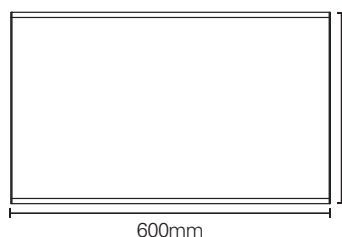

1000W

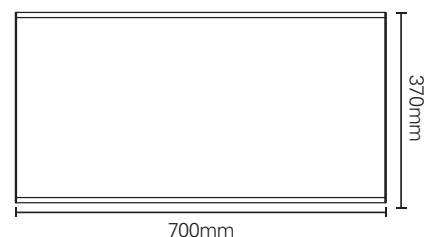

MÅ IKKE TILDEKkes/
DO NOT COVER

SIKKERHET/SAFETY

Må ikke tildekkes, ovnens overflate kan bli svært varm og må plasseres i trygg avstand fra brennbart materia le. Koble fra strømmen ved ved likehold. Ved bruk av skjoteledning må den være kortest mulig og være utstrakt når ovnen er på.

Do not cover the heater surface, the heater can become very hot and must be placed at a safe distance from flammable material. Disconnect power during maintenance. If using an extension cord it must be as short as possible and be extended when the oven is on.

Information requirement for the electric local space heaters

Model identifier(s):5401374/5401391					
Item	Symbol	Value	Unit	Item	Unit
Heat output				Type of heat input, for electric storage local space heaters only (select one)	
Nominal heat output	P _{nom}	0.34-0.4	kW	manual heat charge control, with integrated thermostat	No
Minimum heat output (indicative)	P _{min}	0.34	kW	manual heat charge control with room and/or outdoor temperature feedback	No
Maximum continuous heat output	P _{max,c}	0.40	kW	electronic heat charge control with room and/or outdoor temperature feedback	No
Auxiliary electricity consumption				fan assisted heat output	
At nominal heat output				Type of heat output/room temperature control (select one)	
At minimum heat output				single stage heat output and no room temperature control	
In standby mode				Two or more manual stages, no room temperature control	
				with mechanic thermostat room temperature control	
				with electronic room temperature control	
				electronic room temperature control plus day timer	
				electronic room temperature control plus week timer	
				Other control options (multiple selections possible)	
				room temperature control, with presence detection	
				room temperature control, with open window detection	
				with distance control option	
				with adaptive start control	
				with working time limitation	
				with black bulb sensor	
Contact details	Namron AS - Nedre Kalbakkvei 88B, N-1081 Oslo - NORWAY				

Information requirement for the electric local space heaters

Model identifier(s):5401375 / 5401378					
Item	Symbol	Value	Unit	Item	Unit
Heat output				Type of heat input, for electric storage local space heaters only (select one)	
Nominal heat output	P _{nom}	0.5-0.6	kW	manual heat charge control, with integrated thermostat	No
Minimum heat output (indicative)	P _{min}	0.50	kW	manual heat charge control with room and/or outdoor temperature feedback	No
Maximum continuous heat output	P _{max,c}	0.60	kW	electronic heat charge control with room and/or outdoor temperature feedback	No
Auxiliary electricity consumption				fan assisted heat output	
At nominal heat output	e _{lmax}	N/A	kW	Type of heat output/room temperature control (select one)	
At minimum heat output	e _{lmin}	N/A	kW	single stage heat output and no room temperature control	No
In standby mode	e _{lSB}	0.00016	kW	Two or more manual stages, no room temperature control	No
				with mechanic thermostat room temperature control	No
				with electronic room temperature control	No
				electronic room temperature control plus day timer	No
				electronic room temperature control plus week timer	Yes
				Other control options (multiple selections possible)	
				room temperature control, with presence detection	No
				room temperature control, with open window detection	Yes
				with distance control option	No
				with adaptive start control	No
				with working time limitation	No
				with black bulb sensor	No
Contact details	Namron AS - Nedre Kalbakkvei 88B, N-1081 Oslo - NORWAY				

Information requirement for the electric local space heaters

Model identifier(s):5401376 / 5401379					
Item	Symbol	Value	Unit	Item	Unit
Heat output				Type of heat input, for electric storage local space heaters only (select one)	
Nominal heat output	P _{nom}	0.67-0.8	kW	manual heat charge control, with integrated thermostat	No
Minimum heat output (indicative)	P _{min}	0.67	kW	manual heat charge control with room and/or outdoor temperature feedback	No
Maximum continuous heat output	P _{max,c}	0.80	kW	electronic heat charge control with room and/or outdoor temperature feedback	No
Auxiliary electricity consumption				fan assisted heat output	
At nominal heat output				Type of heat output/room temperature control (select one)	
At minimum heat output				single stage heat output and no room temperature control	
In standby mode				Two or more manual stages, no room temperature control	
				with mechanic thermostat room temperature control	
				with electronic room temperature control	
				electronic room temperature control plus day timer	
				electronic room temperature control plus week timer	
				Other control options (multiple selections possible)	
				room temperature control, with presence detection	
				room temperature control, with open window detection	
				with distance control option	
				with adaptive start control	
				with working time limitation	
				with black bulb sensor	
Contact details	Namron AS - Nedre Kalbakkvei 88B, N-1081 Oslo - NORWAY				

Information requirement for the electric local space heaters

Model identifier(s):5401377 / 5401380					
Item	Symbol	Value	Unit	Item	Unit
Heat output				Type of heat input, for electric storage local space heaters only (select one)	
Nominal heat output	P _{nom}	0.85-1.0	kW	manual heat charge control, with integrated thermostat	No
Minimum heat output (indicative)	P _{min}	0.85	kW	manual heat charge control with room and/or outdoor temperature feedback	No
Maximum continuous heat output	P _{max,c}	1.00	kW	electronic heat charge control with room and/or outdoor temperature feedback	No
Auxiliary electricity consumption				fan assisted heat output	
At nominal heat output				Type of heat output/room temperature control (select one)	
At minimum heat output				single stage heat output and no room temperature control	
In standby mode				Two or more manual stages, no room temperature control	
				with mechanic thermostat room temperature control	
				with electronic room temperature control	
				electronic room temperature control plus day timer	
				electronic room temperature control plus week timer	
				Other control options (multiple selections possible)	
				room temperature control, with presence detection	
				room temperature control, with open window detection	
				with distance control option	
				with adaptive start control	
				with working time limitation	
				with black bulb sensor	
Contact details		Namron AS - Nedre Kalbakkvei 88B, N-1081 Oslo - NORWAY			